



# Tbilisi Grand Slam 2024

Georgia, Tbilisi, 22-24 Mar 2024

## -73 kg

Seniors (54)

### POOL A

|  |                          |     |
|--|--------------------------|-----|
|  | HASHIMOTO Soichi         | JPN |
|  | KHALIDOV Said-Magomed    | UKR |
|  | HAMAD Sulaiman           | KSA |
|  | ARDINA Vinicius          | BRA |
|  | SHEROV Abubakr           | TKJ |
|  | KABISOV Azamat           | AIN |
|  | ABDURAKHMANOV Bakhtizhan | KAZ |
|  | ESTRADA Magdiel          | CUB |
|  | MUNNINGS Andrew          | BAH |
|  | DIMITRIADI Christos      | CYP |
|  | KHALISHVILI Saba         | GEO |
|  | KIM Chol Gwang           | PRK |
|  | HOJAK Martin             | SLO |

|   |                        |    |
|---|------------------------|----|
| 1 | HASHIMOTO S. (JPN)     |    |
| 2 | KHALIDOV S. (UKR)      | 33 |
| 3 | SHEROV A. (TKJ)        |    |
| 4 | ABDURAKHMANOV B. (KAZ) | 34 |
| 5 | ESTRADA M. (CUB)       |    |
| 6 | DIMITRIADI C. (CYP)    | 35 |
| 7 | KIM C. (PRK)           |    |
| 8 | HOJAK M. (SLO)         | 36 |

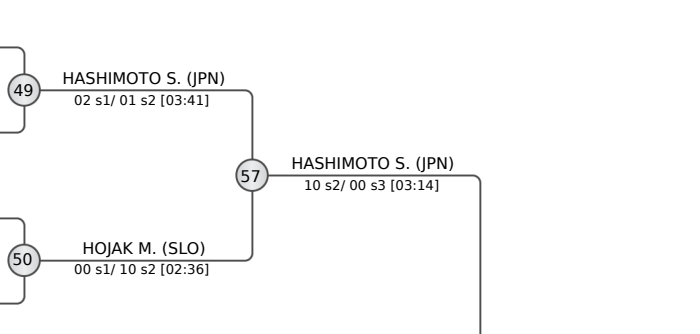

### POOL B

|  |                        |     |
|--|------------------------|-----|
|  | MARGELIDON Arthur      | CAN |
|  | TAI TIN William        | SAM |
|  | GALSTIAN Karen         | AIN |
|  | ABDULAEV Karim         | UAE |
|  | CINCI Furkan           | TUR |
|  | ALIKAJ Ahmad           | IRT |
|  | SANCHO Julian          | CRC |
|  | CASES ROCA Salvador    | ESP |
|  | VIERU Denis            | MDA |
|  | VITKAUSKAS Kestutis    | LTU |
|  | AN Jaehong             | KOR |
|  | KAPANADZE Luka         | GEO |
|  | GOMES Thelmo           | POR |
|  | GABLER Alexander Bernd | GER |

|    |                     |    |
|----|---------------------|----|
| 9  | MARGELIDON A. (CAN) |    |
| 10 | GALSTIAN K. (AIN)   | 37 |
| 11 | ABDULAEV K. (UAE)   |    |
| 12 | ALIKAJ A. (IRT)     | 38 |
| 13 | CASES ROCA S. (ESP) |    |
| 14 | VIERU D. (MDA)      | 39 |
| 15 | KAPANADZE L. (GEO)  |    |
| 16 | GABLER A. (GER)     | 40 |

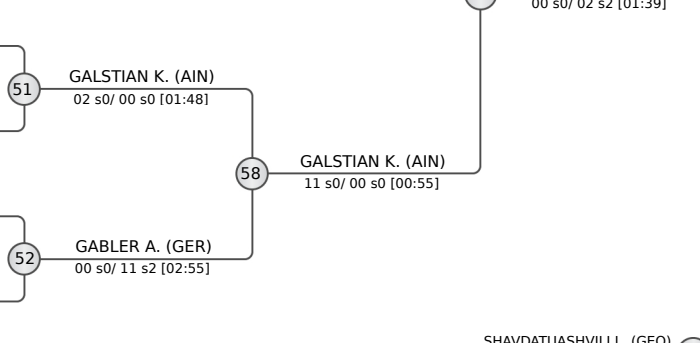

### POOL C

|  |                        |     |
|--|------------------------|-----|
|  | YULDOSHEV Murodjon     | UZB |
|  | HALAVACHOU Ruslan      | AIN |
|  | HAMMAD Abdullah        | KSA |
|  | HRISTOV Mark           | BUL |
|  | ALIYEV Ibrahim         | AZE |
|  | TERADA Masayuki        | THA |
|  | NAKANO Keisei          | PHI |
|  | BUTBUL Tohar           | ISR |
|  | METELLUS Philippe Abel | HAI |
|  | TOROSYAN Artak         | ARM |
|  | MARCELINO Michael      | BRA |
|  | AKSOY Eren             | TUR |
|  | ANDREOU Kyprianos      | CYP |
|  | CHIKHELIDZE Giorgi     | GEO |

|    |                      |    |
|----|----------------------|----|
| 17 | YULDOSHEV M. (UZB)   |    |
| 18 | HALAVACHOU R. (AIN)  | 41 |
| 19 | HRISTOV M. (BUL)     |    |
| 20 | TERADA M. (THA)      | 42 |
| 21 | BUTBUL T. (ISR)      |    |
| 22 | TOROSYAN A. (ARM)    | 43 |
| 23 | MARCELINO M. (BRA)   |    |
| 24 | CHIKHELIDZE G. (GEO) | 44 |

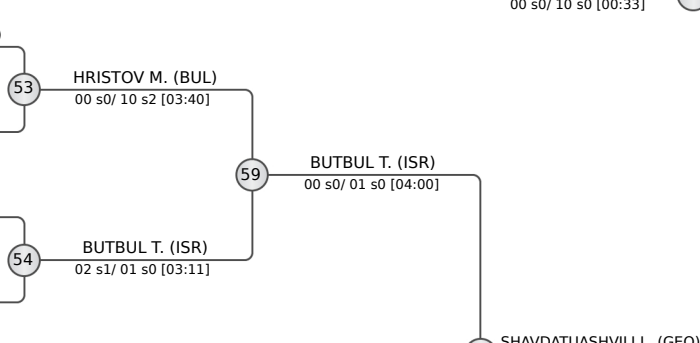

### POOL D

|  |                       |     |
|--|-----------------------|-----|
|  | SHAVDATUASHVILI Lasha | GEO |
|  | WANDTKE Igor          | GER |
|  | MENDEZ Ulises         | MEX |
|  | GREEN Joshua          | IRL |
|  | OTMANÉ Luca           | FRA |
|  | MORKA Ksawery         | POL |
|  | YONEZUKA Jack         | USA |
|  | RAICU Alexandru       | ROU |
|  | MAJIDI Kavan          | IRT |
|  | DE LUCIA Facundo      | ARG |
|  | NURKOVIC Jahja        | MNE |
|  | KANG Heoncheol        | KOR |
|  | CANO GARCIA Jorge     | ESP |

|    |                          |    |
|----|--------------------------|----|
| 25 | SHAVDATUASHVILI L. (GEO) |    |
| 26 | WANDTKE I. (GER)         | 45 |
| 27 | GREEN J. (IRL)           |    |
| 28 | MORKA K. (POL)           | 46 |
| 29 | YONEZUKA J. (USA)        |    |
| 30 | RAICU A. (ROU)           | 47 |
| 31 | NURKOVIC J. (MNE)        |    |
| 32 | KANG H. (KOR)            | 48 |

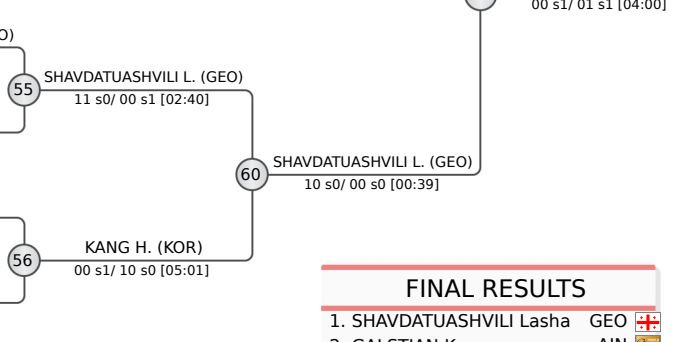

### REPECHAGE

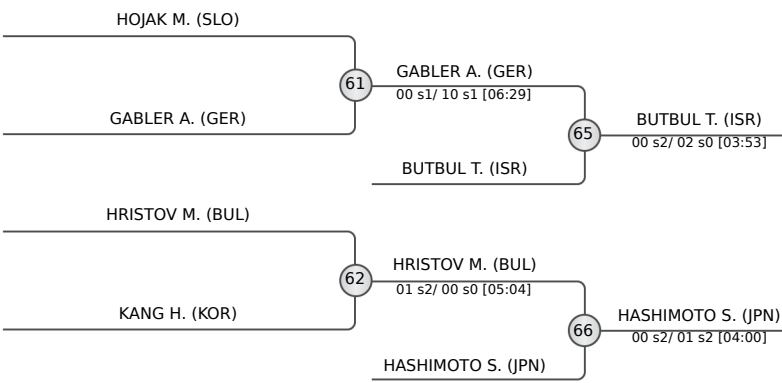

### FINAL RESULTS

|    |                        |     |  |
|----|------------------------|-----|--|
| 1. | SHAVDATUASHVILI Lasha  | GEO |  |
| 2. | GALSTIAN Karen         | AIN |  |
| 3. | BUTBUL Tohar           | ISR |  |
| 4. | HASHIMOTO Soichi       | JPN |  |
| 5. | GABLER Alexander Bernd | GER |  |
| 7. | HRISTOV Mark           | BUL |  |
| 7. | HOJAK Martin           | SLO |  |
| 7. | KANG Heoncheol         | KOR |  |





# Tbilisi Grand Slam 2024

Georgia, Tbilisi, 22-24 Mar 2024

# -81 kg

Seniors (53)

POOL A

|   |                                 |   |                           |                      |                      |                     |                      |
|---|---------------------------------|---|---------------------------|----------------------|----------------------|---------------------|----------------------|
| 1 | GAUTHIER DRAPEAU Francois (CAN) | 1 | GAUTHIER DRAPEAU F. (CAN) | 33                   | SULCA A. (ROU)       |                     |                      |
| 2 | SULCA Adrian (ROU)              | 2 | SULCA A. (ROU)            | 01 s2/ 00 s2 [07:36] | 00 s3/ 10 s1 [02:31] |                     |                      |
| 3 | GERELTUYA Bolor-Ochir (MGL)     | 3 | DVALASHVILI Z. (GEO)      | 00 s1/ 01 s1 [04:00] | 49                   | BONFERRONI A. (SUI) | 00 s0/ 11 s1 [00:49] |
| 4 | DVALASHVILI Zaur (GEO)          | 4 | BONFERRONI A. (SUI)       | 00 s0/ 01 s2 [04:00] | 34                   | BONFERRONI A. (SUI) | 00 s0/ 01 s2 [04:00] |
| 5 | KLADNOV Arsenii (KGZ)           | 5 | SVIDRAK M. (UKR)          | 00 s1/ 02 s0 [02:37] | 57                   | BOLTABOEV S. (UZB)  | 00 s1/ 01 s2 [04:00] |
| 6 | BONFERRONI Aurelien (SUI)       | 6 | BOLTABOEV S. (UZB)        | 00 s1/ 01 s1 [04:00] | 50                   | BOLTABOEV S. (UZB)  | 01 s2/ 00 s0 [04:00] |
| 7 | SVIDRAK Mykhailo (UKR)          | 7 | REBAHI K. (QAT)           | 00 s0/ 02 s0 [00:29] | 36                   | KOPECKY A. (CZE)    | 00 s1/ 02 s0 [03:17] |
| 8 | PEREZ Jorge (CHI)               | 8 | KOPECKY A. (CZE)          | 00 s1/ 02 s0 [03:17] |                      |                     |                      |
|   | BOLTABOEV Sharofiddin (UZB)     |   |                           |                      |                      |                     |                      |
|   | DAVIS Bryan (USA)               |   |                           |                      |                      |                     |                      |
|   | REBAHI Khalil (QAT)             |   |                           |                      |                      |                     |                      |
|   | KOPECKY Adam (CZE)              |   |                           |                      |                      |                     |                      |

POOL B

|    |                            |    |                       |                      |                       |                       |                      |
|----|----------------------------|----|-----------------------|----------------------|-----------------------|-----------------------|----------------------|
| 9  | TATALASHVILI Nugzari (UAE) | 9  | TATALASHVILI N. (UAE) | 37                   | TATALASHVILI N. (UAE) | 01 s2/ 00 s2 [04:00]  |                      |
| 10 | ARAB Sibghatullah (IRT)    | 10 | BAISIEV T. (AIN)      | 00 s2/ 10 s2 [04:00] | 51                    | TATALASHVILI N. (UAE) | 10 s2/ 00 s3 [05:55] |
| 11 | BAISIEV Taulan (AIN)       | 11 | EGUTIDZE A. (POR)     | 10 s2/ 00 s2 [04:49] | 38                    | EGUTIDZE A. (POR)     | 10 s2/ 00 s3 [04:57] |
| 12 | EGUTIDZE Anri (POR)        | 12 | GANDIA A. (PUR)       | 10 s2/ 00 s3 [04:57] |                       |                       |                      |
| 13 | PIERRE Baptiste (FRA)      | 13 | LATISEV M. (MDA)      | 00 s1/ 02 s1 [03:07] | 39                    | RAJABLI O. (AZE)      | 00 s1/ 02 s1 [03:07] |
| 14 | GANDIA Adrian (PUR)        | 14 | RAJABLI O. (AZE)      | 10 s2/ 00 s0 [02:42] | 52                    | RAJABLI O. (AZE)      | 10 s0/ 00 s0 [00:56] |
| 15 | LATISEV Mihail (MDA)       | 15 | RESSEL D. (GER)       | 00 s3/ 10 s2 [03:50] | 40                    | RESSEL D. (GER)       | 10 s1/ 00 s0 [02:26] |
| 16 | RAJABLI Omar (AZE)         | 16 | MEDEIROS P. (BRA)     | 00 s1/ 10 s0 [02:52] |                       |                       |                      |
| 17 | MORALES Tomas (ARG)        |    |                       |                      |                       |                       |                      |
| 18 | AKHALKATSI Vladimir (GEO)  |    |                       |                      |                       |                       |                      |
| 19 | RESSEL Dominic (GER)       |    |                       |                      |                       |                       |                      |
| 20 | BADALYAN Mesrop (ARM)      |    |                       |                      |                       |                       |                      |
| 21 | MEDEIROS Pedro (BRA)       |    |                       |                      |                       |                       |                      |

POOL C

|    |                                     |    |                              |                      |                 |                              |                      |
|----|-------------------------------------|----|------------------------------|----------------------|-----------------|------------------------------|----------------------|
| 17 | MAKHMADBEKOV Somon (TJK)            | 17 | MAKHMADBEKOV S. (TJK)        | 41                   | STERPU V. (MDA) | 00 s0/ 02 s1 [02:24]         |                      |
| 18 | STERPU Victor (MDA)                 | 18 | STERPU V. (MDA)              | 10 s1/ 00 s3 [02:14] | 53              | ARBUZOV T. (AIN)             | 00 s0/ 11 s0 [01:36] |
| 19 | ALBALI Abdulelah (KSA)              | 19 | SVOBODA J. (CZE)             | 02 s1/ 01 s0 [01:21] | 42              | ARBUZOV T. (AIN)             | 00 s0/ 10 s0 [01:05] |
| 20 | SVOBODA Jan (CZE)                   | 20 | ARBUZOV T. (AIN)             | 00 s2/ 10 s0 [02:42] |                 |                              |                      |
| 21 | REBAHI Mohamed (QAT)                | 21 | DEL ORBE CORTORREAL M. (DOM) | 01 s1/ 00 s2 [04:55] | 43              | DEL ORBE CORTORREAL M. (DOM) | 01 s1/ 00 s2 [04:55] |
| 22 | GRAMATIKOV Georgi (BUL)             | 22 | KAPANADZE K. (GEO)           | 02 s0/ 00 s0 [01:06] | 54              | FALCAO G. (BRA)              | 00 s3/ 10 s0 [04:42] |
| 23 | ARBUZOV Timur (AIN)                 | 23 | FALCAO G. (BRA)              | 10 s0/ 00 s1 [01:16] | 44              | FALCAO G. (BRA)              | 10 s1/ 00 s1 [02:02] |
| 24 | DEL ORBE CORTORREAL Medickson (DOM) | 24 | SOGENOV I. (SRB)             | 01 s1/ 00 s1 [04:50] |                 |                              |                      |
|    |                                     |    |                              |                      |                 |                              |                      |
|    |                                     |    |                              |                      |                 |                              |                      |
|    |                                     |    |                              |                      |                 |                              |                      |
|    |                                     |    |                              |                      |                 |                              |                      |
|    |                                     |    |                              |                      |                 |                              |                      |

POOL D

|    |                              |    |                      |                      |               |                      |                      |
|----|------------------------------|----|----------------------|----------------------|---------------|----------------------|----------------------|
| 25 | MUKI Sagi (ISR)              | 25 | MUKI S. (ISR)        | 45                   | MUKI S. (ISR) | 01 s2/ 00 s1 [07:37] |                      |
| 26 | MASABIROV Asad (KGZ)         | 26 | IMAMVERDIEV M. (AZE) | 00 s2/ 01 s1 [04:00] | 55            | MUKI S. (ISR)        | 02 s2/ 00 s1 [02:21] |
| 27 | IMAMVERDIEV Magerram (AZE)   | 27 | ZOUBKO D. (FRA)      | 10 s0/ 00 s2 [03:50] | 46            | MURTOZOEV N. (UZB)   | 00 s3/ 10 s2 [02:18] |
| 28 | ZOUBKO Daniyl (FRA)          | 28 | MURTOZOEV N. (UZB)   | 00 s3/ 10 s2 [02:18] |               |                      |                      |
| 29 | DEMOURTSIDIS Theodoros (GRE) | 29 | CAVELIUS T. (GER)    | 00 s1/ 10 s0 [02:27] | 47            | MOORHEAD L. (GBR)    | 00 s1/ 10 s0 [02:27] |
| 30 | MURTOZOEV Nurbek (UZB)       | 30 | MOORHEAD L. (GBR)    | 00 s3/ 10 s1 [06:58] | 56            | GOCHILAI D. (GEO)    | 00 s2/ 10 s0 [02:59] |
| 31 | CAVELIUS Timo (GER)          | 31 | AMANGELDI M. (KAZ)   | 11 s0/ 00 s1 [01:49] | 48            | GOCHILAI D. (GEO)    | 00 s1/ 11 s1 [01:53] |
| 32 | STEWART Max (JAM)            | 32 | GOCHILAI D. (GEO)    | 10 s0/ 00 s0 [00:52] |               |                      |                      |
|    | MOORHEAD Lachlan (GBR)       |    |                      |                      |               |                      |                      |
|    | AMANGELDI Madi (KAZ)         |    |                      |                      |               |                      |                      |
|    | SHERIFOVSKI Edi (MKD)        |    |                      |                      |               |                      |                      |
|    | GOCHILAI D. Dimitri (GEO)    |    |                      |                      |               |                      |                      |
|    | NUWARAPAKSHA Rajitha (SRI)   |    |                      |                      |               |                      |                      |

REPECHAGE

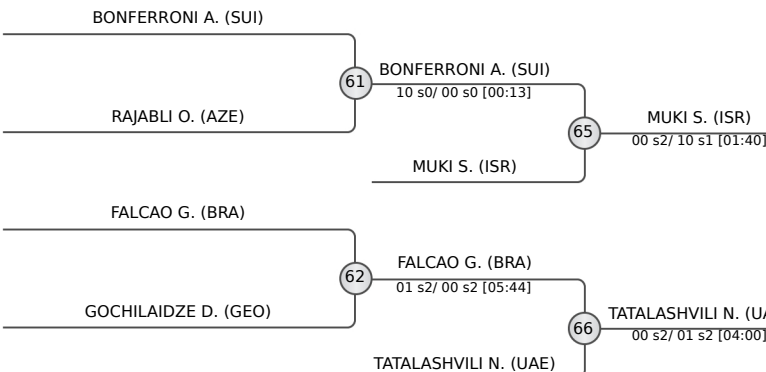

| FINAL RESULTS |                             |
|---------------|-----------------------------|
| 1.            | ARBUZOV Timur (AIN)         |
| 2.            | BOLTABOEV Sharofiddin (UZB) |
| 3.            | MUKI Sagi (ISR)             |
| 5.            | TATALASHVILI Nugzari (UAE)  |
| 5.            | BONFERRONI Aurelien (SUI)   |
| 7.            | RAJABLI Omar (AZE)          |
| 7.            | GOCHILAI D. Dimitri (GEO)   |





# Tbilisi Grand Slam 2024

Georgia, Tbilisi, 22-24 Mar 2024

## -63 kg

Seniors (39)

POOL A

|    |                             |     |
|----|-----------------------------|-----|
| 1  | BEAUCHEMIN-PINARD Catherine | CAN |
| 2  | PADILLA GUERRERO Sarai      | ESP |
| 3  | TSIKLAURI Nino              | GEO |
| 4  | SHAHEEN Nigara              | IRT |
| 5  | DEBERDT Gaetane             | FRA |
| 6  | QUADROS Ketleyn             | BRA |
| 7  | MANANNIKOVA Anastasiia      | AIN |
| 8  | COUGHLAN Maeve              | AUS |
| 9  | IVANESCU Florentina         | ROU |
| 10 | SOTNIKOVA Kristina          | KAZ |

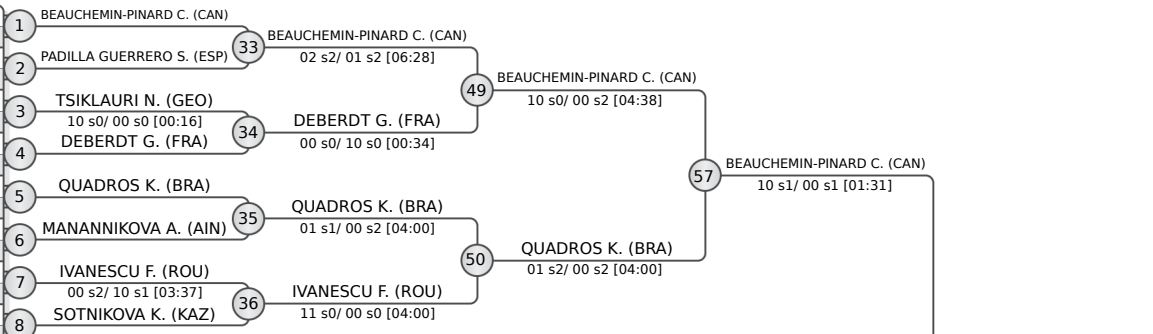

POOL B

|    |                     |     |
|----|---------------------|-----|
| 9  | LESKI Andreja       | SLO |
| 10 | MINKINA Ekaterina   | AIN |
| 11 | POHL Dena           | GER |
| 12 | FAVORINI Flavia     | ITA |
| 13 | TANG Jing           | CHN |
| 14 | VAN LIESHOUT Joanne | NED |
| 15 | KRSSAKOVA Magdalena | AUT |
| 16 | ZACHOVA Renata      | CZE |
| 17 | BOLD Gankhaich      | MGL |

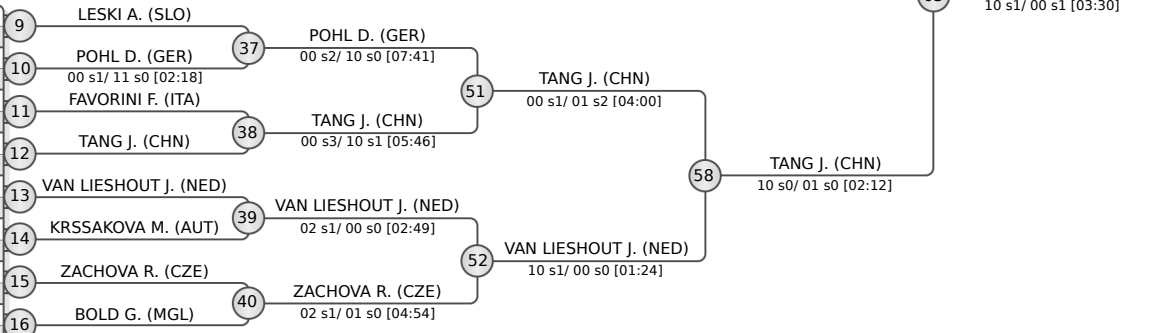

POOL C

|    |                          |     |
|----|--------------------------|-----|
| 17 | FAZLIU Laura             | KOS |
| 18 | LKHAGVATOGOO Enkhriilen  | MGL |
| 19 | KARADEMIR Eda            | TUR |
| 20 | VAN DEN BERG Geke        | NED |
| 21 | MAKRETSKAYA Yana         | AIN |
| 22 | AWITI ALCARAZ Prisca     | MEX |
| 23 | RUSSO Savita             | ITA |
| 24 | DASHKINOVA Zulhumar      | TKM |
| 25 | MANOVA Yoana             | BUL |
| 26 | DEL TORO CARVAJAL Maylin | CUB |

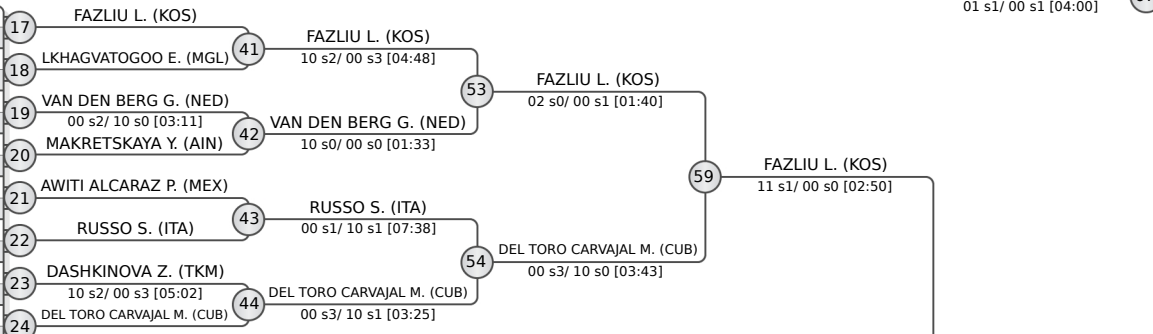

POOL D

|    |                       |     |
|----|-----------------------|-----|
| 25 | HAECKER Katharina     | AUS |
| 26 | SILVA Nauana          | BRA |
| 27 | CABANA PEREZ Cristina | ESP |
| 28 | KRISTO Katarina       | CRO |
| 29 | KIM Jisu              | KOR |
| 30 | SZYMANSKA Angelika    | POL |
| 31 | SCHMIDT Agatha        | GER |
| 32 | OBRADOVIC Anja        | SRB |
| 33 | UTNELISHVILI Regina   | GEO |
| 34 | TURPIN Melodie        | FRA |

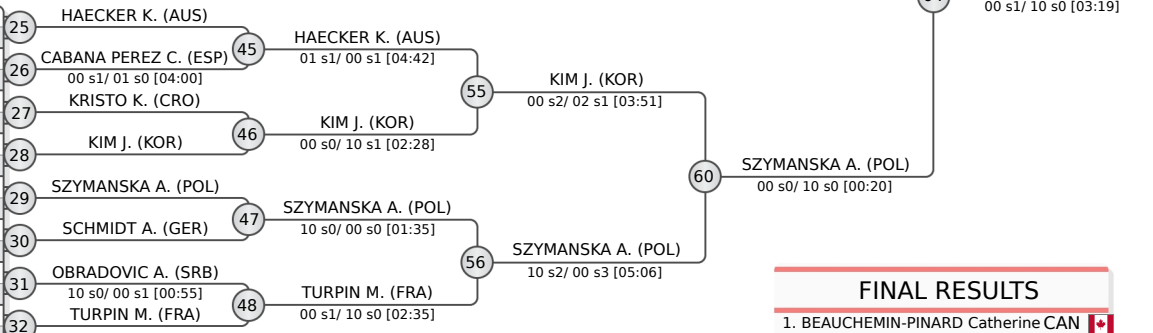

REPECHAGE

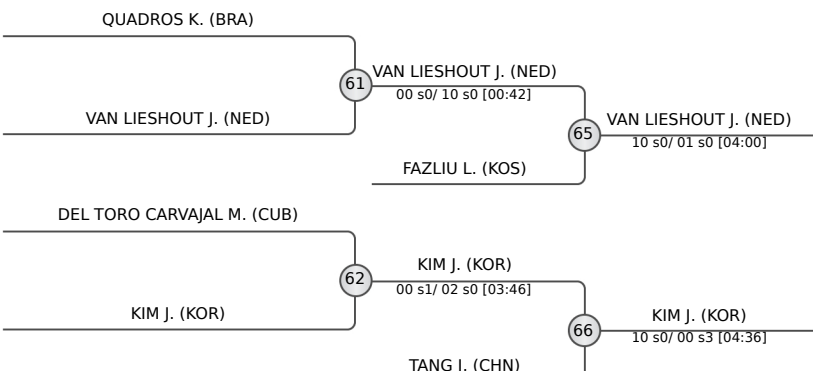

| FINAL RESULTS |                                 |
|---------------|---------------------------------|
| 1.            | BEAUCHEMIN-PINARD Catherine CAN |
| 2.            | SZYMANSKA Angelika POL          |
| 3.            | VAN LIESHOUT Joanne NED         |
| 4.            | KIM Jisu KOR                    |
| 5.            | FAZLIU Laura KOS                |
| 6.            | TANG Jing CHN                   |
| 7.            | QUADROS Ketleyn BRA             |
| 8.            | DEL TORO CARVAJAL Maylin CUB    |





# Tbilisi Grand Slam 2024

Georgia, Tbilisi, 22-24 Mar 2024

## -70 kg

Seniors (37)

POOL A

|  |                      |     |   |                      |    |
|--|----------------------|-----|---|----------------------|----|
|  | VAN DIJKE Sanne      | NED | 1 | VAN DIJKE S. (NED)   |    |
|  | ESPOSITO Martina     | ITA | 2 | ESPOSITO M. (ITA)    | 33 |
|  | ERIKSSON Ida         | SWE | 3 | ERIKSSON I. (SWE)    |    |
|  | LISHCHENKO Tamara    | AIN |   | 01 s2/ 00 s2 [04:46] |    |
|  | HAWKES Rachael       | IRL | 4 | HAWKES R. (IRL)      | 34 |
|  | POGACNIK Anka        | SLO | 5 | POGACNIK A. (SLO)    |    |
|  | GULBANI Nino         | GEO | 6 | GULBANI N. (GEO)     | 35 |
|  | TOKAREVA Ekaterina   | KAZ | 7 | TOKAREVA E. (KAZ)    |    |
|  | BATSUURI Nyam-Erdene | MGL | 8 | BATSUURI N. (MGL)    | 36 |
|  |                      |     |   | 01 s1/ 00 s0 [04:57] |    |

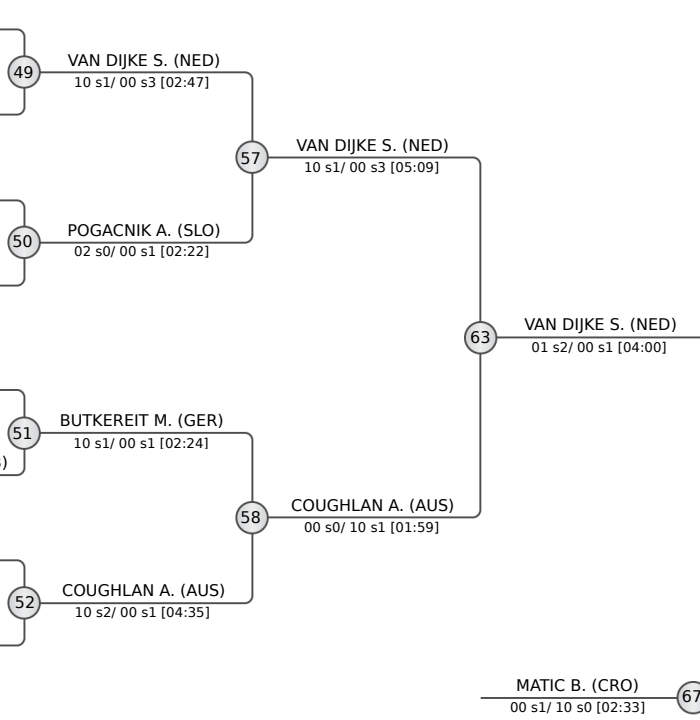

POOL B

|  |                          |     |    |                      |    |
|--|--------------------------|-----|----|----------------------|----|
|  | BUTKEREIT Miriam         | GER | 9  | BUTKEREIT M. (GER)   |    |
|  | SAMARDZIC Aleksandra     | BIH | 10 | SAMARDZIC A. (BIH)   | 37 |
|  | YEATS-BROWN Katie-Jemima | GBR | 11 | YEATS-BROWN K. (GBR) |    |
|  | FRONER Ellen             | BRA |    | 10 s0/ 00 s0 [00:57] |    |
|  | MATNIYAZOVA Gulnoza      | UZB | 12 | MATNIYAZOVA G. (UZB) | 38 |
|  | MATNIYAZOVA G. (UZB)     |     |    | 01 s2/ 11 s1 [06:29] |    |
|  | COUGHLAN Aoife           | AUS | 13 | COUGHLAN A. (AUS)    |    |
|  | WROBLEWSKA Eliza         | POL | 14 | WROBLEWSKA E. (POL)  | 39 |
|  | MYERS Melissa            | USA | 15 | MYERS M. (USA)       |    |
|  | KVARTSKHAVA Lizi         | GEO |    | 10 s0/ 00 s0 [00:00] |    |
|  | SOULA Florine            | FRA | 16 | SOULA F. (FRA)       | 40 |
|  |                          |     |    | 00 s0/ 02 s0 [01:02] |    |

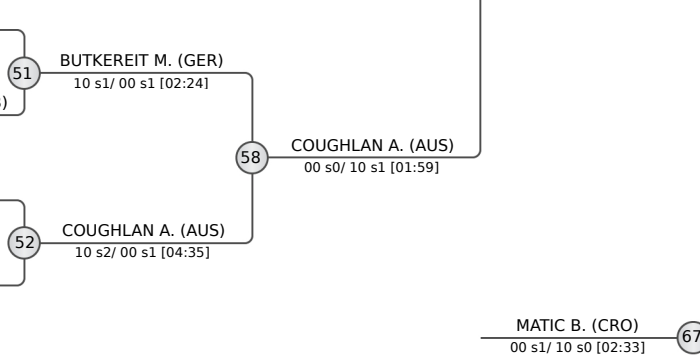

POOL C

|  |                    |     |    |                      |    |
|--|--------------------|-----|----|----------------------|----|
|  | MATIC Barbara      | CRO | 17 | MATIC B. (CRO)       |    |
|  | CARVALHO Luana     | BRA | 18 | CARVALHO L. (BRA)    | 41 |
|  | NAZAROVA Shokhista | UZB | 19 | NAZAROVA S. (UZB)    |    |
|  | CHAYEB Aqulina     | LBN | 20 | CHAYEB A. (LBN)      | 42 |
|  | PEREZ Maria        | PUR | 21 | PEREZ M. (PUR)       |    |
|  | AZAMOVA Firuza     | AIN |    | 00 s3/ 10 s2 [04:54] |    |
|  | YU Hyeonji         | KOR | 22 | YU H. (KOR)          | 43 |
|  | JAGER Hilde        | NED | 23 | JAGER H. (NED)       |    |
|  | TCHANTURIA Mariam  | GEO | 24 | TCHANTURIA M. (GEO)  | 44 |
|  |                    |     |    | 10 s0/ 00 s3 [03:12] |    |

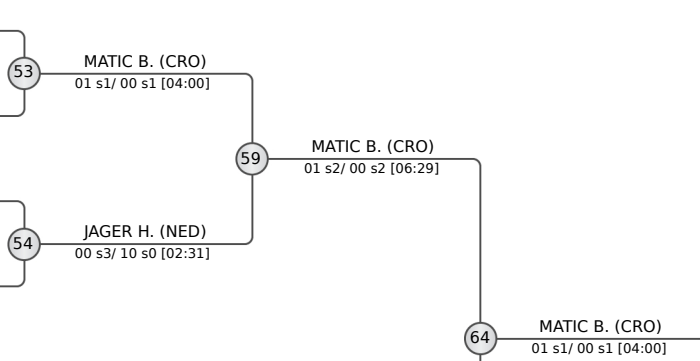

POOL D

|  |                        |     |    |                           |    |
|--|------------------------|-----|----|---------------------------|----|
|  | TELTSIDOU Elisavet     | GRE | 25 | TELTSIDOU E. (GRE)        |    |
|  | PETERSEN POLLARD Kelly | GBR | 26 | PETERSEN POLLARD K. (GBR) | 45 |
|  | YU Dan                 | CHN | 27 | YU D. (CHN)               |    |
|  | KOREN Nika             | SLO | 28 | KOREN N. (SLO)            | 46 |
|  | SCOCCIMARRO Giovanna   | GER | 29 | SCOCCIMARRO G. (GER)      |    |
|  | JARROT Lucie           | FRA | 30 | JARROT L. (FRA)           | 47 |
|  | PEDROTTI Irene         | ITA | 31 | PEDROTTI I. (ITA)         |    |
|  | MUN Song Hui           | PRK |    | 10 s2/ 00 s3 [05:00]      |    |
|  | PILECKAITE Ugne        | LTU | 32 | PILECKAITE U. (LTU)       | 48 |
|  |                        |     |    | 01 s0/ 00 s1 [04:00]      |    |

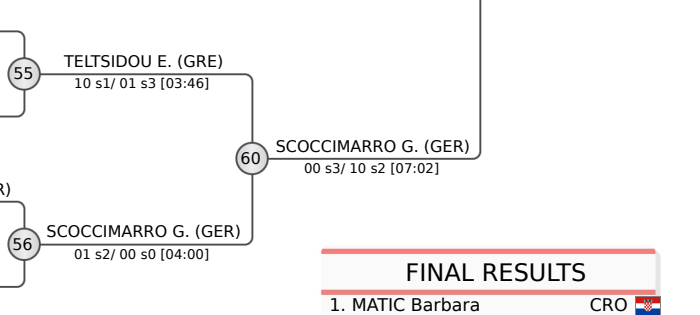

REPECHAGE

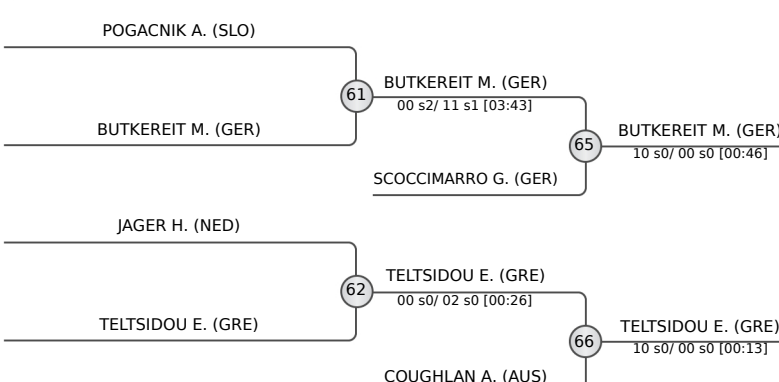

| FINAL RESULTS |                          |
|---------------|--------------------------|
| 1.            | MATIC Barbara CRO        |
| 2.            | VAN DIJKE Sanne NED      |
| 3.            | BUTKEREIT Miriam GER     |
| 4.            | TELTSIDOU Elisavet GRE   |
| 5.            | SCOCCIMARRO Giovanna GER |
| 6.            | COUGHLAN Aoife AUS       |
| 7.            | POGACNIK Anka SLO        |
|               | JAGER Hilde NED          |

