



Millennium Team European Cadet Championships Skopje 2025 Individuals

North Macedonia, Skopje, 26-28 Jun 2025

-66 kg
Cadets (33)

POOL A

SRB	1	JANKOVIC B. (SRB)	33	JANKOVIC B. (SRB)	100 s1/ 000 s1 [01:41]
BUL	2	DIMITROV K. (BUL)			
IJF	3	NIBO T. (IJF)	34	NIBO T. (IJF)	111 s0/ 000 s0 [02:23]
KOS	4	DELIU R. (KOS)			
AZE	5	HUMBATOV A. (AZE)	35	NAGIMULIN A. (GER)	001 s0/ 110 s0 [01:48]
GER	6	NAGIMULIN A. (GER)			
HUN	7	GAL K. (HUN)	36	PABERZIS A. (LAT)	001 s0/ 010 s1 [04:00]
LAT	8	PABERZIS A. (LAT)			

POOL B

CZE	9	OTEVREL T. (CZE)	37	OTEVREL T. (CZE)	100 s0/ 000 s1 [01:14]
MKD	10	ELEZI O. (MKD)			
DEN	11	PAUSKIC S. (DEN)	38	MALKHASYAN G. (ARM)	001 s0/ 110 s0 [04:00]
ARM	12	MALKHASYAN G. (ARM)			
EST	13	NOGES G. (EST)	39	NOGES G. (EST)	100 s0/ 000 s0 [02:11]
GBR	14	ANDRIICHUK V. (GBR)			
SVK	15	NEMASIK M. (SVK)	40	ROTASNIUC I. (MDA)	001 s1/ 101 s0 [03:29]
MDA	16	ROTASNIUC I. (MDA)			

POOL C

LTU	17	KARALEVICIUS Z. (LTU)	41	KARALEVICIUS Z. (LTU)	001 s1/ 000 s2 [07:11]
GEO	18	GOGADZE Z. (GEO)			
ARM	19	UMRSHADYAN H. (ARM)	42	TABET I. (FRA)	000 s2/ 100 s1 [00:59]
FRA	20	TABET I. (FRA)			
IJF	21	KHAMKHOEV R. (IJF)	43	KHAMKHOEV R. (IJF)	100 s0/ 000 s0 [00:38]
BUL	22	NIKOLOV P. (BUL)			
LAT	23	HOMKA E. (LAT)	44	ERCOLI A. (ITA)	000 s1/ 001 s1 [04:00]
ITA	24	ERCOLI A. (ITA)			

POOL D

NOR	25	GUBBERUD N. (NOR)	45	GUBBERUD N. (NOR)	101 s0/ 000 s0 [00:47]
MKD	26	PANCHEVSKI M. (MKD)			
GBR	27	MENSHYKOV V. (GBR)	46	ONAY N. (TUR)	000 s0/ 100 s0 [01:35]
GRE	28	POSNAKIDIS Theodoros			
TUR	28	ONAY N. (TUR)			
CRO	29	ROZGA R. (CRO)	47	ROZGA R. (CRO)	100 s1/ 000 s3 [04:35]
NED	30	DAAMEN J. (NED)			
AUT	31	STOEGMANN S. (AUT)	48	STOEGMANN S. (AUT)	100 s0/ 000 s0 [01:14]
EST	32	LAVRINJOV V. (EST)			

REPECHAGE

61	DELIU R. (KOS)	65	JANKOVIC B. (SRB)	69	JANKOVIC B. (SRB)	101 s0/ 000 s1 [03:08]
62	ANDRIICHUK V. (GBR)	66	ROTASNIUC I. (MDA)	70	OTEVREL T. (CZE)	000 s1/ 001 s0 [04:00]
63	NIKOLOV P. (BUL)	67	ERCOLI A. (ITA)	71	TABET I. (FRA)	000 s2/ 100 s1 [02:30]
64	PANCHEVSKI M. (MKD)	68	ONAY N. (TUR)	72	STOEGMANN S. (AUT)	000 s1/ 100 s0 [01:27]

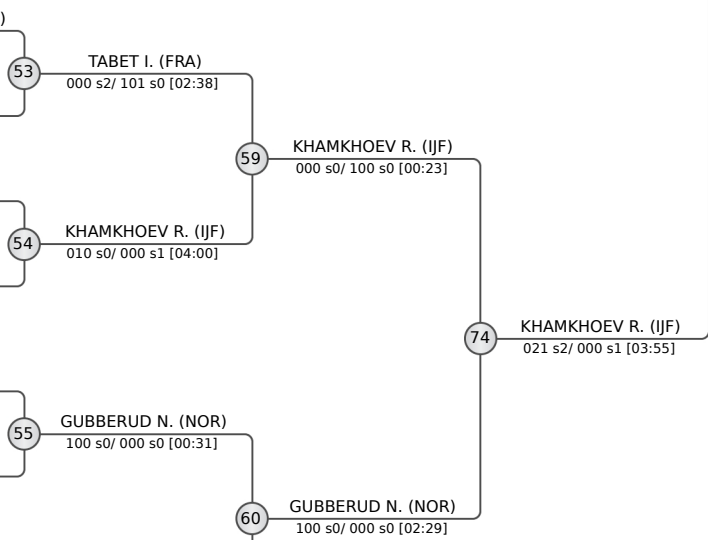
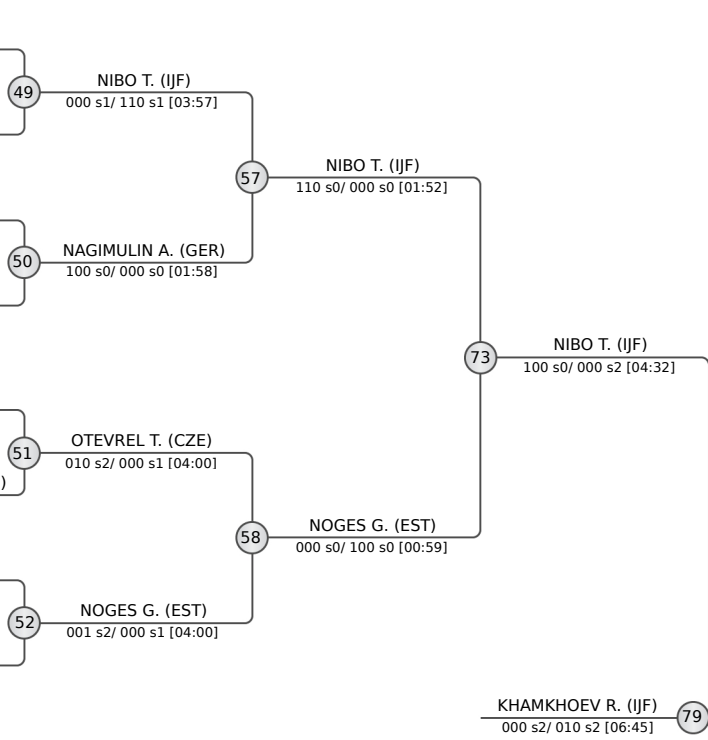

FINAL RESULTS		
1.	KHAMKHOEV Rakhim	IJF
2.	NIBO Tamerlan	IJF
3.	OTEVREL Tomas	CZE
3.	NOGES Georg	EST
5.	GUBBERUD Nino	NOR
5.	TABET Ishak	FRA
7.	JANKOVIC Boris	SRB
7.	STOEGMANN Stefan	AUT





Millennium Team European Cadet Championships Skopje 2025 Individuals

North Macedonia, Skopje, 26-28 Jun 2025

-73 kg
Cadets (32)

POOL A

	VARNICIC Veljko	SRB
	PAVARS Markuss	LAT
	HRISTOFOROV Bruno	EST
	GRIGORJEV Emilis	LTU
	KUTATELADZE Luka	GEO
	OSKIN Ilia	MDA
	LAZARIDES Stefanos	CYP
	TOMAS Michal	SVK

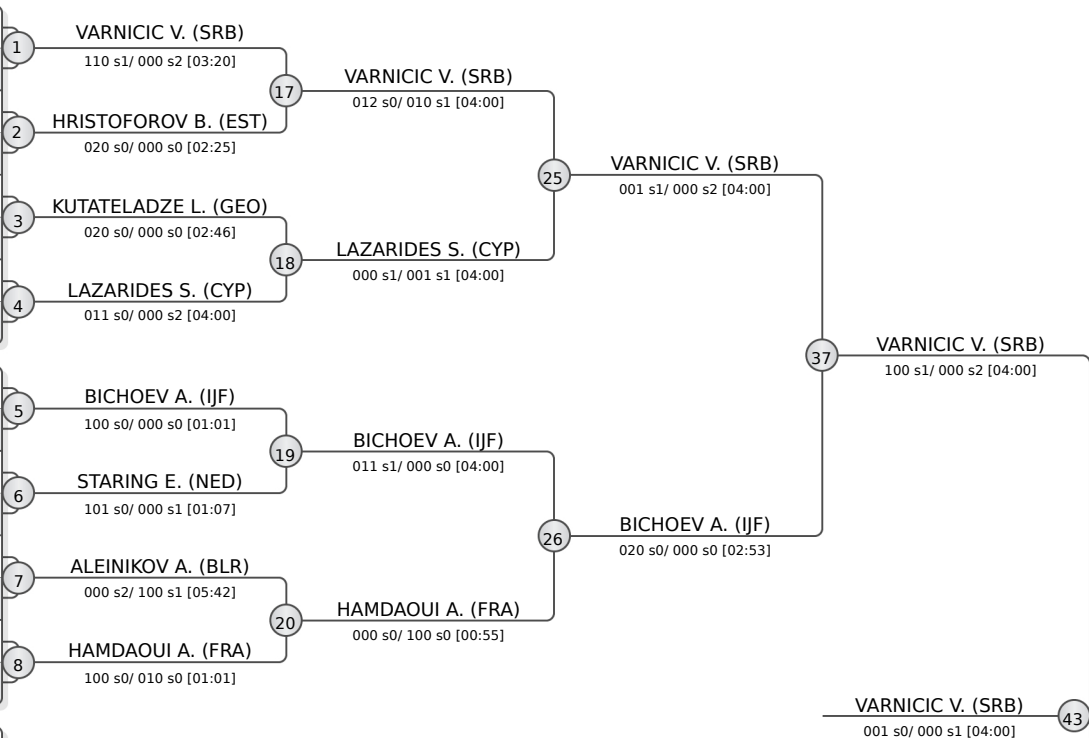

POOL B

	BICHOEV Atkhan	IJF
	GKOLIAS Efthymios	GRE
	STARING Eros	NED
	GALSTYAN Gor	ARM
	SHARIFOV Said	AZE
	ALEINIKOV Alexandr	BLR
	HAMDAOUI Ahmed-Adam	FRA
	TANCOCK Lenny	GBR

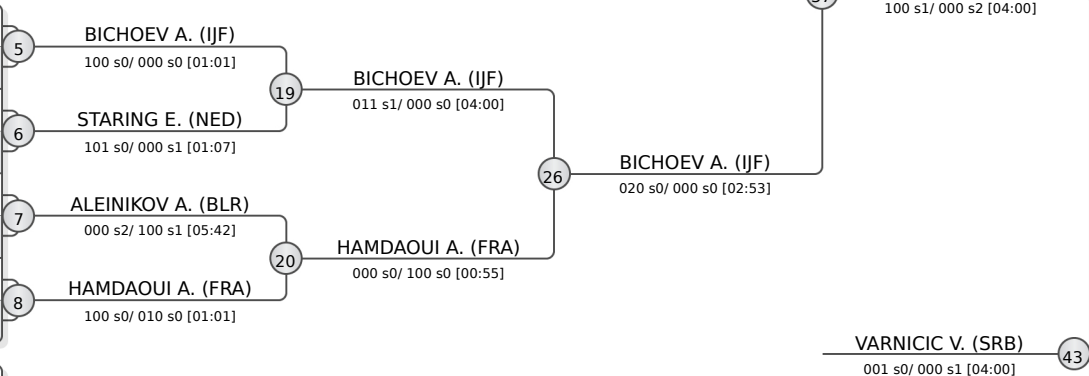

POOL C

	GAMEZARDASHVILI Vasil	GEO
	SARUKHANYAN Tigran	ARM
	STOJCHESKI Antonio	MKD
	MIHALEV Nikolaz	BUL
	HASANLI Aykhan	AZE
	GIGILASHVILI Luka	GBR
	BRACCIOFORTE Giuseppe	ITA
	MESIC Omar	BIH

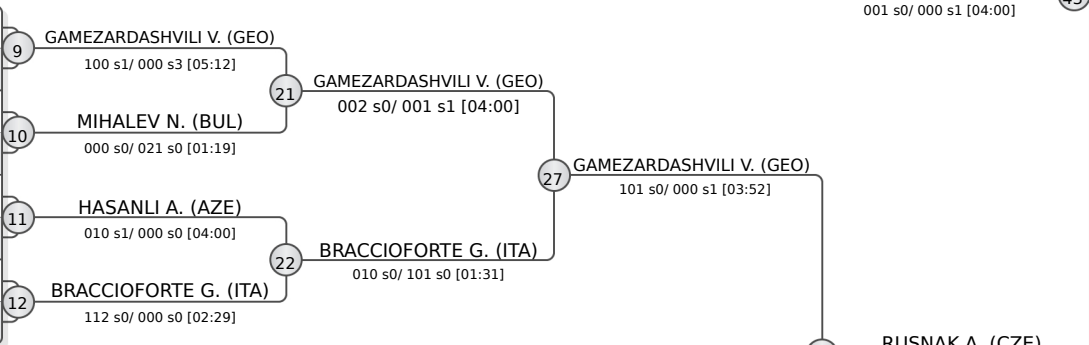

POOL D

	MILJIC Sinisa	SRB
	TAMMIN Daniel	EST
	RUSNAK Adam	CZE
	HAIJIYEV Ali	SWE
	HAVRANEK Josip	CRO
	KODRIC Luka	SLO
	SPETSIOS Kyriakos	CYP
	TAVARES Guilherme	POR

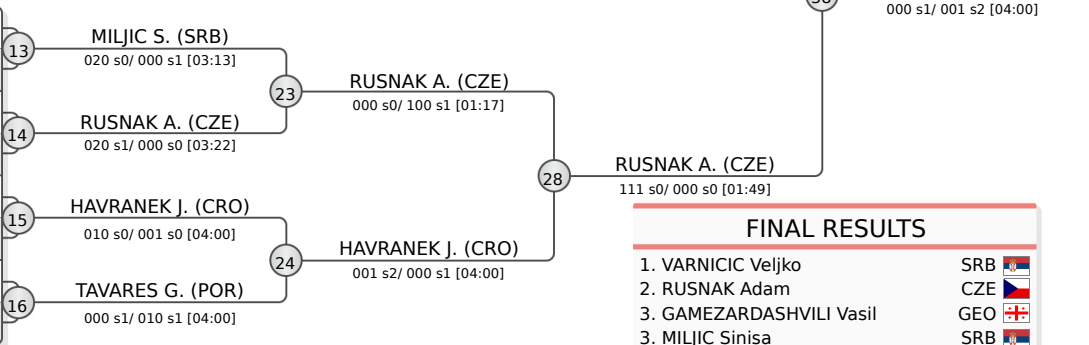

FINAL RESULTS		
1.	VARNICIC Veljko	SRB
2.	RUSNAK Adam	CZE
3.	GAMEZARDASHVILI Vasil	GEO
3.	MILJIC Sinisa	SRB
5.	HAMDAOUI Ahmed-Adam	FRA
5.	BICHOEV Atkhan	IJF
7.	LAZARIDES Stefanos	CYP
7.	BRACCIOFORTE Giuseppe	ITA

REPECHAGE

PAVARS M. (LAT)	HRISTOFOROV B. (EST)	29
HRISTOFOROV B. (EST)	LAZARIDES S. (CYP)	33
GKOLIAS E. (GRE)	STARING E. (NED)	30
STARING E. (NED)	HAMDAOUI A. (FRA)	34
SARUKHANYAN T. (ARM)	MIHALEV N. (BUL)	31
MIHALEV N. (BUL)	BRACCIOFORTE G. (ITA)	35
HAIJIYEV A. (SWE)	MILJIC S. (SRB)	32
MILJIC S. (SRB)	HAVRANEK J. (CRO)	36

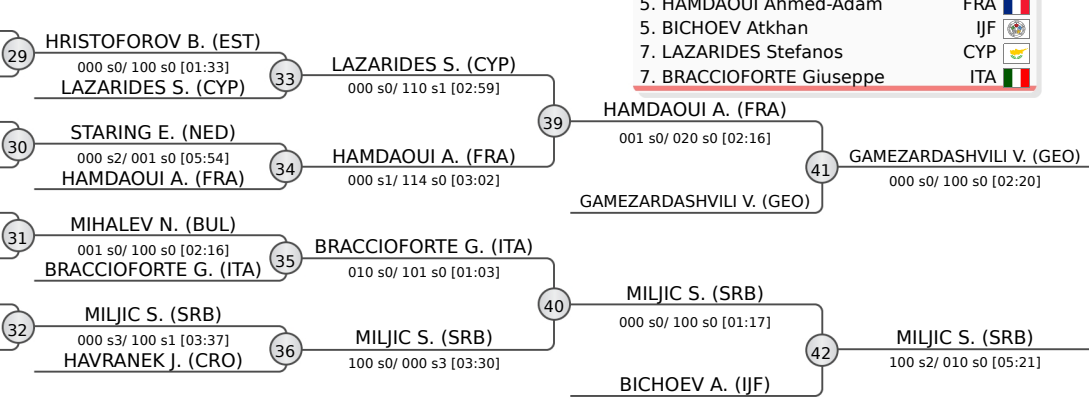



Millennium Team European Cadet Championships Skopje 2025 Individuals

North Macedonia, Skopje, 26-28 Jun 2025

-52 kg
Cadets (30)

POOL A

	KOZLOVA Valeriia	IJF
	ZHARSKAYA Alisiya	BLR
	ROBINSON Lucy	GBR
	BAILLEUL Helea	FRA
	SIMIC Tea	BIH
	CHIRON Alexandra	MDA
	IOSIFIDOU Veroniki	GRE

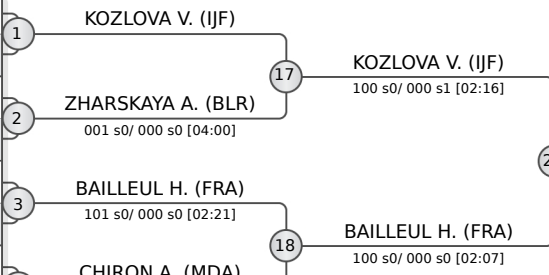

POOL B

	MOS Marika	POL
	SIMIC Andjela	SRB
	VADOVICOVA Vivien	SVK
	ZARUBA Viktorija	LTU
	MAMMADOVA Aysun	AZE
	GASPAR Sofia	POR
	DODAJ Sidorela	KOS
	ILIOSKA Tamara	MKD

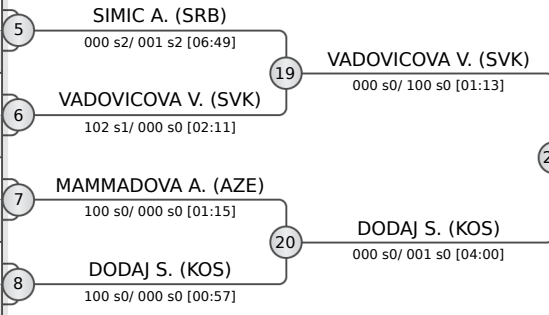

POOL C

	VAS Mira	HUN
	VAINER Xenia	MDA
	XAVIER Maria	POR
	CORDOVA Sofia	SWE
	GULIASHVILI Mariam	GEO
	LOPEZ Alice	FRA
	JOVANOVA Daria	MKD

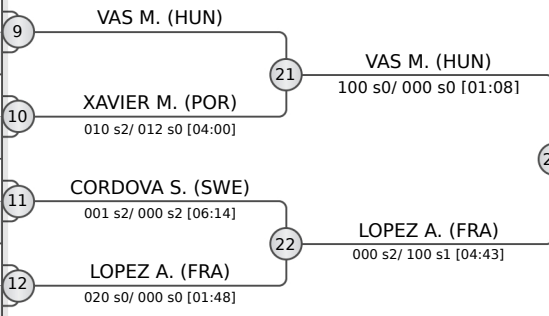

POOL D

	MARTINEZ DE RITUERTO MORILLAS Monica	ESP
	MARKOVA Maraya	BUL
	PAPADOPOULOU Eirini-Kleio	GRE
	FURMAN Polina	IJF
	BONZANO Giulia	ITA
	JOVANOVIC Anja	SRB
	HAJIZADA Nurana	AZE
	SIMIC Mia	BIH

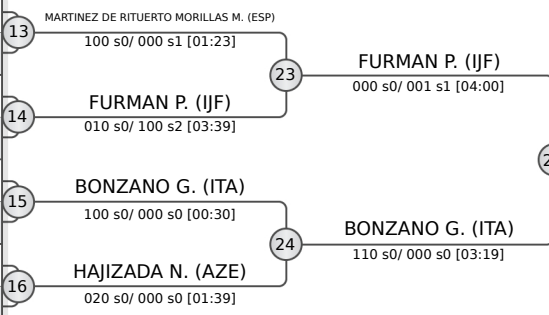

REPECHAGE

ZHARSKAYA A. (BLR)	29	ZHARSKAYA A. (BLR)	33
ILIOSKA T. (MKD)		BAILLEUL H. (FRA)	
MAMMADOVA A. (AZE)	30	MAMMADOVA A. (AZE)	34
JOVANOVA D. (MKD)		VADOVICOVA V. (SVK)	
CORDOVA S. (SWE)	31	CORDOVA S. (SWE)	35
PAPADOPOULOU E. (GRE)		VAS M. (HUN)	
MARTINEZ DE RITUERTO MORILLAS M. (ESP)	32	MARTINEZ DE RITUERTO MORILLAS M. (ESP)	36
		BONZANO G. (ITA)	

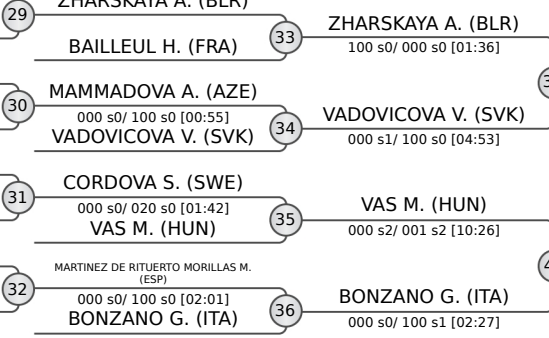

FINAL RESULTS

- KOZLOVA Valeriia IJF
- LOPEZ Alice FRA
- FURMAN Polina IJF
- BONZANO Giulia ITA
- VADOVICOVA Vivien SVK
- DODAJ Sidorela KOS
- ZHARSKAYA Alisiya BLR
- VAS Mira HUN





Millennium Team European Cadet Championships Skopje 2025 Individuals

North Macedonia, Skopje, 26-28 Jun 2025

-57 kg
Cadets (33)

POOL A

GER	TOSZEGI Maya	1	TOSZEGI M. (GER)
GRE	DIMOU Danai	2	DIMOU D. (GRE) 33
LAT	ZUCIKA Ksenija	3	ZUCIKA K. (LAT)
POR	LOURENCO Rita	4	LOURENCO R. (POR) 34
GEO	GULBANI Tinatin	5	GULBANI T. (GEO)
BLR	MINKO Sofiya	6	MINKO S. (BLR) 35
MKD	DRUSHTINAC Hanija	7	RUCHTI N. (SUI) 000 s0/ 100 s0 [00:14]
SUI	RUCHTI Noemi	8	ZHDANOVA E. (IJF) 36
IJF	ZHDANOVA Ekaterina		ZHDANOVA E. (IJF) 000 s0/ 100 s0 [01:30]

POOL B

TUR	KILIC Elif	9	KILIC E. (TUR)
AZE	YUSIFLI Samaya	10	YUSIFLI S. (AZE) 37
ROU	PAVEN Amelia	11	PAVEN A. (ROU)
HUN	BOZSO Zita	12	BOZSO Z. (HUN) 38
SLO	VEINHANDL OBAID Haya	13	VEINHANDL OBAID H. (SLO)
ITA	MORUZZI Rachele	14	MORUZZI R. (ITA) 39
GBR	SHATTOCK Maisie	15	SHATTOCK M. (GBR)
BUL	STOEVA Andrea	16	STOEVA A. (BUL) 40

POOL C

POL	WALEGA Magdalena	17	WALEGA M. (POL)
MDA	RUSU Maria	18	RUSU M. (MDA) 41
SLO	MASTNAK Zarja	19	MASTNAK Z. (SLO)
KOS	ZIJADE Enise	20	ZIJADE E. (KOS) 42
FRA	DYE Isciane	21	DYE I. (FRA)
BIH	JASIKOVAC Nikolina	22	JASIKOVAC N. (BIH) 43
IJF	KIRILLOVA Stefaniia	23	KIRILLOVA S. (IJF)
NED	WILDSCHUT Lieke	24	WILDSCHUT L. (NED) 44

POOL D

GER	KAISER Katharina	25	KAISER K. (GER)
GEO	TATRISHVILI Sopio	26	TATRISHVILI S. (GEO) 45
SWE	BABULFATH Hanna	27	BABULFATH H. (SWE)
HUN	BARTYIK Iza	28	BARTYIK I. (HUN) 46
FIN	PEKKI Sofia	29	PEKKI S. (FIN)
ALB	NDOCI Desara	30	NDOCI D. (ALB) 47
SVK	BOLTVANOV A Lea	31	BOLTVANOV A L. (SVK)
MKD	ILIOSKA Teodora	32	ILIOSKA T. (MKD) 48

REPECHAGE

61	RUCHTI N. (SUI)	65	RUCHTI N. (SUI) 100 s0/ 000 s0 [01:29]
62	YUSIFLI S. (AZE)	66	BOZSO Z. (HUN) 001 s0/ 100 s0 [01:48]
63	RUSU M. (MDA)	67	RUSU M. (MDA) 100 s0/ 000 s0 [00:00]
64	NDOCI D. (ALB)	68	ILIOSKA T. (MKD) 000 s0/ 100 s1 [02:36]

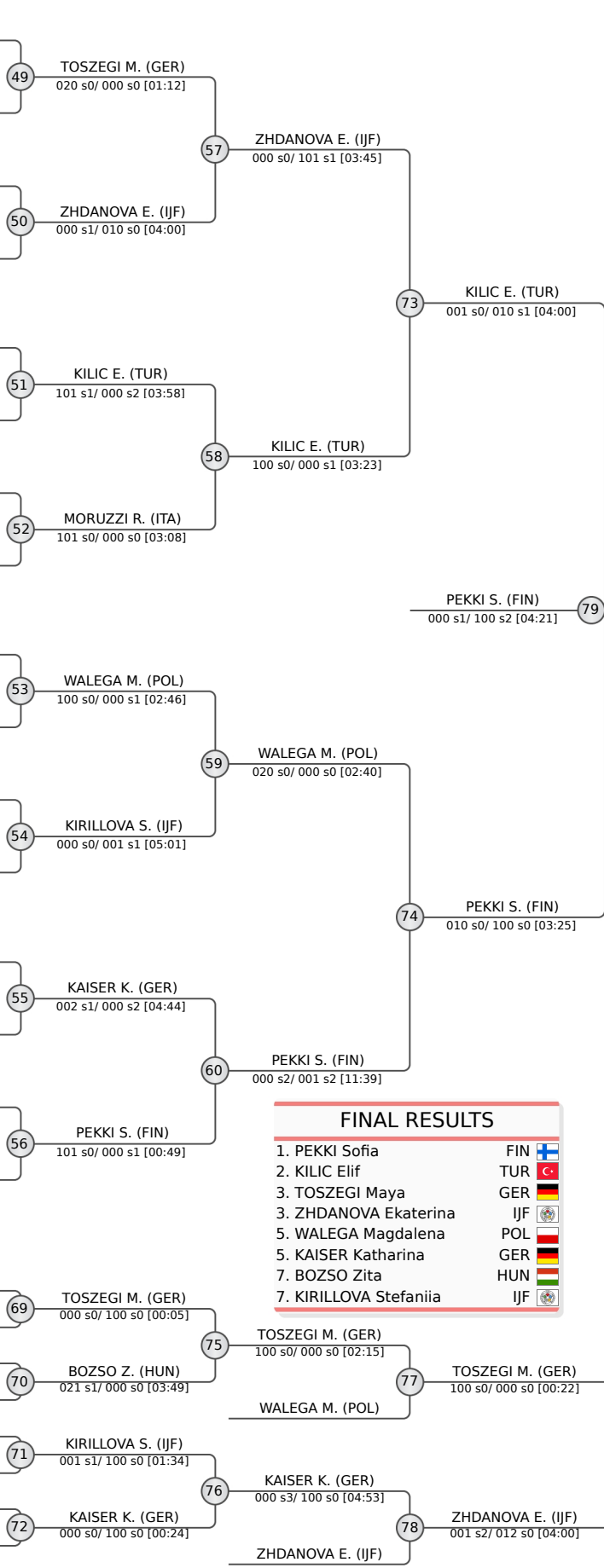

FINAL RESULTS

1. PEKKI Sofia FIN
2. KILIC Elif TUR
3. TOSZEGI Maya GER
3. ZHDANOVA Ekaterina IJF
5. WALEGA Magdalena POL
5. KAISER Katharina GER
7. BOZSO Zita HUN
7. KIRILLOVA Stefaniia IJF





Millennium Team European Cadet Championships Skopje 2025 Individuals

North Macedonia, Skopje, 26-28 Jun 2025

-63 kg
Cadets (27)

POOL A

	WOZNICZKO Nadia	POL
	PAVLOVIC Nevena	SRB
	KULIKAUSKAITE Meida	LTU
	ESCASO HURTADO Visitacion	ESP
	GUENNEUGUES Audren	FRA
	TRAAVIK Asal	NOR
	KILICKAYA Rumeysa Hatice	TUR

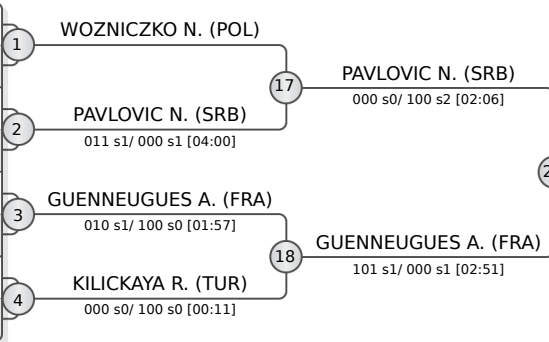

POOL B

	FROSONI Giorgia	ITA
	CHRISAKI Anni-Iris	GRE
	SKILJEVIC Ana	BIH
	LISOUSKAYA Sofya	BLR
	ALEKSIEVA Yoana	BUL
	SABINO Margarida	POR

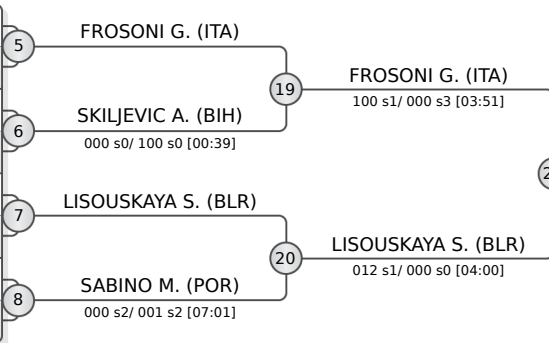

POOL C

	ALIEVA Aishat	IJF
	KRASKO Varvara	BLR
	JANCIKOVA Monika	CZE
	JEAN Chloe	FRA
	ALIYEVA Ayan	AZE
	KORDEL Mira	SWE
	AYDIN Isil Sinem	TUR

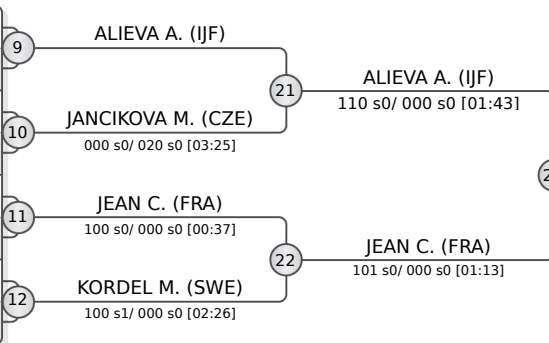

POOL D

	GULBIANI Nana	GEO
	SELAN Paulina	SLO
	PINTER Julia	HUN
	ANDRIC Nina	SRB
	TAXIDOU Eleni	GRE
	BEETERENS Hanne	BEL
	TODOROVA Elitsa	BUL

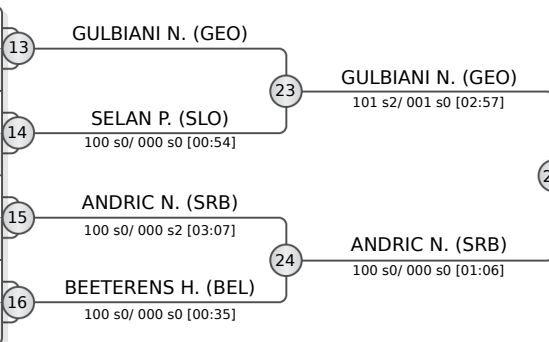

REPECHAGE

ESCASO HURTADO V. (ESP)	29	KILICKAYA R. (TUR)	000 s0/ 100 s0 [03:25]
KILICKAYA R. (TUR)	30	SKILJEVIC A. (BIH)	000 s1/ 101 s1 [01:48]
SKILJEVIC A. (BIH)	31	JANCIKOVA M. (CZE)	000 s3/ 100 s1 [04:00]
JANCIKOVA M. (CZE)	32	SELAN P. (SLO)	100 s1/ 000 s0 [02:39]
SELAN P. (SLO)	33	PAVLOVIC N. (SRB)	100 s1/ 000 s0 [01:17]
KILICKAYA R. (TUR)	34	LISOUSKAYA S. (BLR)	110 s0/ 000 s0 [01:00]
SKILJEVIC A. (BIH)	35	JEAN C. (FRA)	000 s3/ 100 s1 [04:00]
JANCIKOVA M. (CZE)	36	ANDRIC N. (SRB)	100 s1/ 000 s0 [02:39]
SELAN P. (SLO)	37	GUENNEUGUES A. (FRA)	100 s1/ 000 s0 [01:33]
PAVLOVIC N. (SRB)	38	ALIEVA A. (IJF)	000 s0/ 100 s0 [01:29]
SKILJEVIC A. (BIH)	39	GUENNEUGUES A. (FRA)	100 s0/ 000 s0 [01:57]
LISOUSKAYA S. (BLR)	40	ALIEVA A. (IJF)	100 s0/ 000 s0 [01:57]
JANCIKOVA M. (CZE)	41	ALIEVA A. (IJF)	100 s0/ 000 s0 [01:57]
JEAN C. (FRA)	42	ALIEVA A. (IJF)	100 s0/ 000 s0 [01:57]
SELAN P. (SLO)	43	ALIEVA A. (IJF)	100 s0/ 000 s0 [01:57]
ANDRIC N. (SRB)	44	ALIEVA A. (IJF)	100 s0/ 000 s0 [01:57]

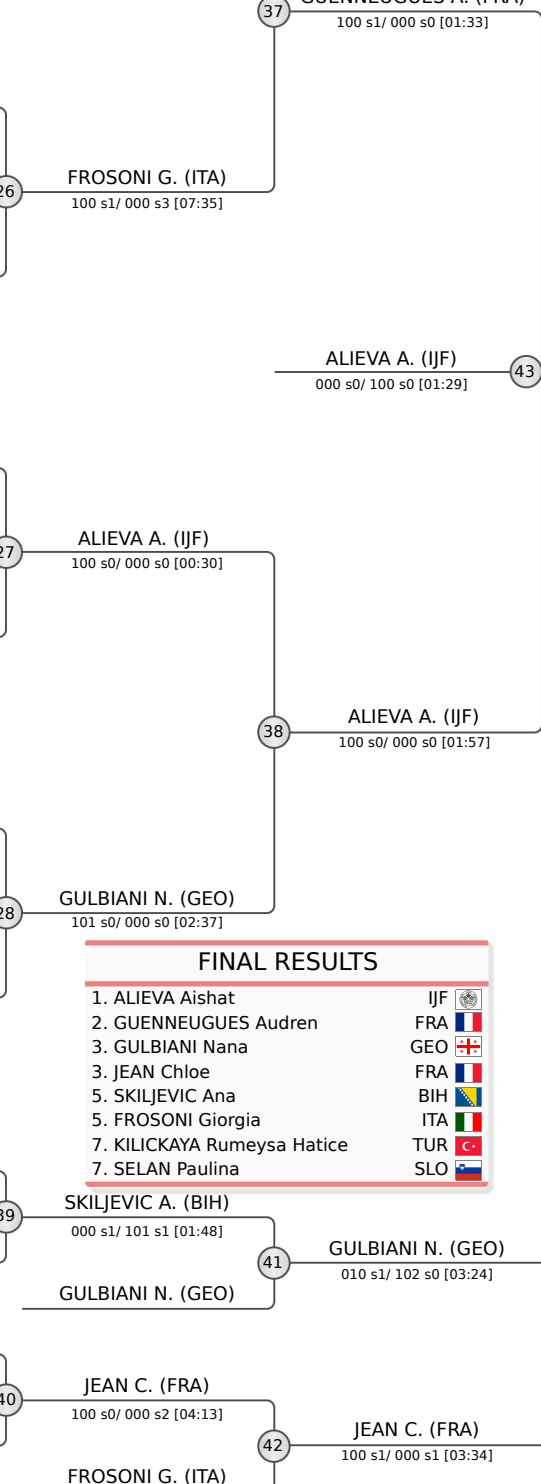

FINAL RESULTS		
1.	ALIEVA Aishat	IJF
2.	GUENNEUGUES Audren	FRA
3.	GULBIANI Nana	GEO
3.	JEAN Chloe	FRA
5.	SKILJEVIC Ana	BIH
5.	FROSONI Giorgia	ITA
7.	KILICKAYA Rumeysa Hatice	TUR
7.	SELAN Paulina	SLO

