



European Judo Championships Juniors Bratislava 2025

Slovakia, Bratislava, 4-6 Sep 2025

-73 kg

Juniors (34)

POOL A

1	GOGINASHVILI Irakli (GBR)	33	GOGINASHVILI I. (GBR)
2	KURAU LI Iakovos (CYP)	34	CROITORU R. (MDA)
3	CROITORU Renat (MDA)	35	TAVOLETTA L. (ITA)
4	MARLOV Alexander (SWE)	36	AKOTO R. (GER)
5	TAVOLETTA Lucio (ITA)	37	YUSUBOV A. (AZE)
6	HAGER Samuel (SVK)	38	JOVSA D. (LTU)
7	GOKER Yucel (TUR)	39	KATIC L. (CRO)
8	MECIOSEK Fran (SLO)	40	VELICKOVIC B. (SRB)
	AKOTO Raphael (GER)		TALAKA Y. (BLR)

POOL B

9	YUSUBOV Abil (AZE)	41	JEAN P. (FRA)
10	KOTZACHRISTOS Georgios (GRE)	42	DUBOVIK A. (BLR)
11	MAITIN Stevan (SUI)	43	VARDANIAN N. (SWE)
12	JOVSA Devidas (LTU)	44	BULOCINIC T. (ISR)
13	SKERLEV Victor (BUL)	45	LEVY B. (GBR)
14	KATIC Luka (CRO)	46	UVEGES A. (HUN)
15	VELICKOVIC Bogdan (SRB)	47	BOULEMTAFES D. (FRA)
16	TALAKA Yahor (BLR)	48	GKINIS N. (GRE)

POOL C

17	JEAN Peter (FRA)	49	GOGINASHVILI I. (GBR)
18	STEMPOVSCHI Tristan (MDA)	50	TAVOLETTA L. (ITA)
19	EPIFANOV Platon (IJF)	51	YUSUBOV A. (AZE)
20	DUBOVIK Anton (BLR)	52	SKERLEV V. (BUL)
21	VARDANIAN Narek (SWE)	53	JEAN P. (FRA)
22	PICCOLO Gabriele (ITA)	54	VARDANIAN N. (SWE)
23	VAN DER VEEN Quinten (NED)	55	LEVY B. (GBR)
24	BULOCINIC Tom (ISR)	56	BOULEMTAFES D. (FRA)

POOL D

25	LEVY Benjamin (GBR)	57	GOGINASHVILI I. (GBR)
26	NOACK Melvin (GER)	58	SKERLEV V. (BUL)
27	DIMITROV Ivo (BUL)	59	VARDANIAN N. (SWE)
28	UVEGES Attila (HUN)	60	LEVY B. (GBR)
29	BOULEMTAFES Dayyan (FRA)	61	TAVOLETTA L. (ITA)
30	BRISUDA Samuel (SVK)	62	JEAN P. (FRA)
31	GIUNASHVILI Gigi (GEO)	63	GOGINASHVILI I. (GBR)
32	BUNAKOV Iaroslav (IJF)	64	VARDANIAN N. (SWE)
	GKINIS Nikolaos (GRE)		

REPECHAGE

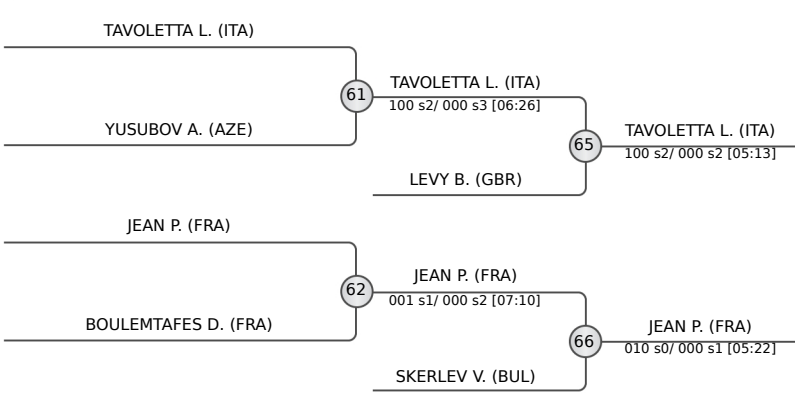

FINAL RESULTS		
1.	GOGINASHVILI Irakli	GBR
2.	VARDANIAN Narek	SWE
3.	TAVOLETTA Lucio	ITA
3.	JEAN Peter	FRA
5.	LEVY Benjamin	GBR
5.	SKERLEV Victor	BUL
7.	YUSUBOV Abil	AZE
7.	BOULEMTAFES Dayyan	FRA





European Judo Championships Juniors Bratislava 2025

Slovakia, Bratislava, 4-6 Sep 2025

-81 kg

Juniors (32)

POOL A

	SHUKUROV Suleyman	AZE
	GRAHOVAC Dusan	SRB
	BAZTAN MERCHAN Inaki	ESP
	DIKAJEV Saad	EST
	COVI Simone	ITA
	LALEIKE Yoshiya	GER
	FRIDMAN ZILBERSTEIN Reem	ISR
	HARBACHOU Yauheni	BLR

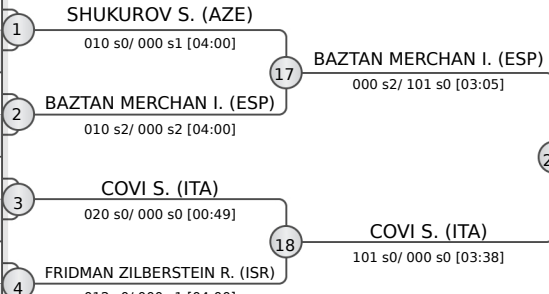

POOL B

	TARKOWSKI Fabrycjusz	POL
	NARKUS Vygidias	LTU
	BAPTISTA Manuel	POR
	AKHLOURI Sandro	GEO
	SZULIK Szymon	POL
	VALCHEV Emil	BUL
	IOANNOU Anastasios	CYP
	ARI Emir Selim	TUR

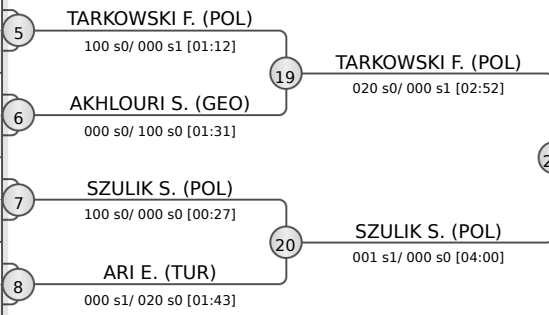

POOL C

	SIMIN Mihajlo	SRB
	CHYZHEVSKYI Ghenadi	MDA
	JOLKIN Nikita	EST
	PILECKAS Aidas	LTU
	GURGEN Erman	TUR
	OULEVEY Thien	SUI
	KAPSOUROU Marios	GRE
	BERTALAN Balazs	HUN

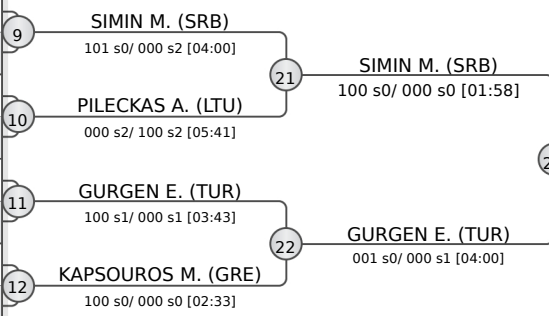

POOL D

	DE LANGE Joshua	NED
	HAJNECKY Marco	SVK
	NEUMANN Eryk	GBR
	SANSONETTI Francesco	ITA
	TURLUEV Akhmed	IJF
	TAHO Paolo	ALB
	RUDENKO Tymofii	ESP
	DURDEVIC Adrian	BIH

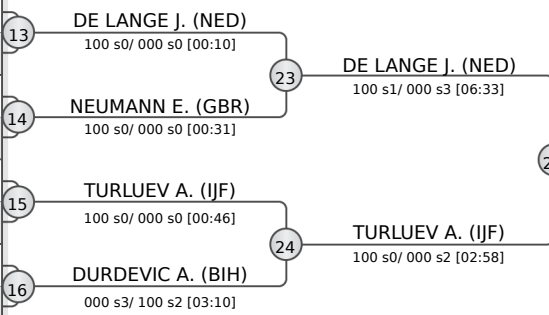

REPECHAGE

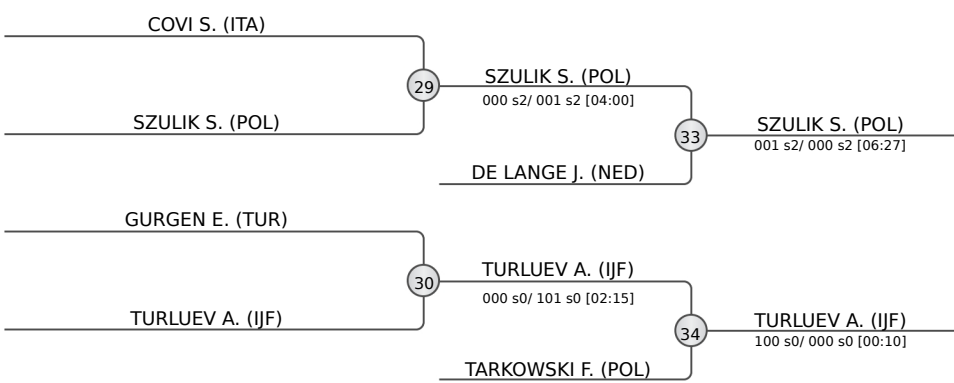

FINAL RESULTS	
1. SIMIN Mihajlo	SRB
2. BAZTAN MERCHAN Inaki	ESP
3. SZULIK Szymon	POL
3. TURLUEV Akhmed	IJF
5. DE LANGE Joshua	NED
5. TARKOWSKI Fabrycjusz	POL
7. COVI Simone	ITA
7. GURGEN Erman	TUR





European Judo Championships Juniors Bratislava 2025

Slovakia, Bratislava, 4-6 Sep 2025

-70 kg

Juniors (21)

POOL A

	FOHOOU April Lynn	SUI
	NAVICKAITE Marta	LTU
	VORACEK Marta	CRO
	ONDEI Serena	ITA
	SITNIK Hanna	BLR
	ANTONOVA Daria	IJF

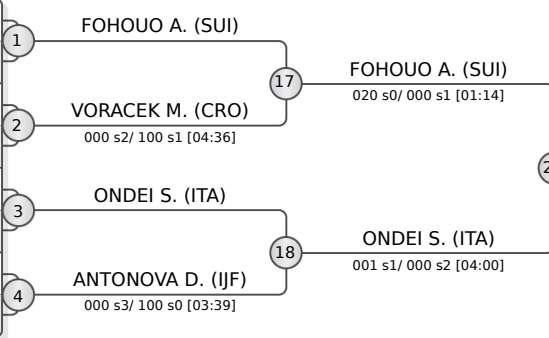

POOL B

	DZIDIC Korina	BIH
	GLUBIAK Magda	POL
	NILSSON Ingrid	SWE
	DESCHEPPER Aicha	BEL
	XANTHOPOULOU Sofia	GRE

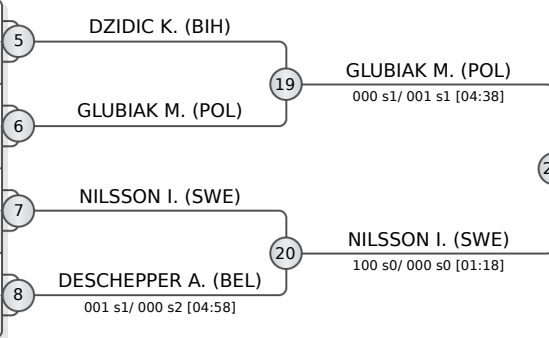

POOL C

	DARBES-TAKAM Teophila	FRA
	JAAFAR Nadie	BUL
	OGNIVOVA Eva	IJF
	BAYR Leonie	AUT
	VIRGILIO Sara	ITA

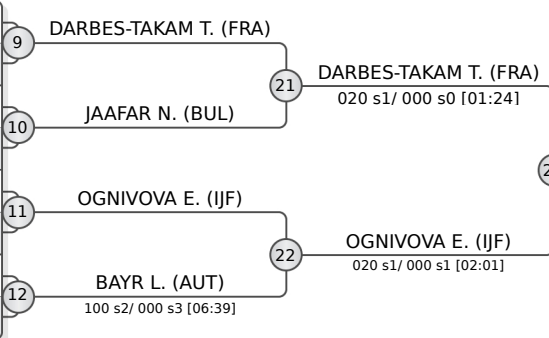

POOL D

	CVJETKO Jana	CRO
	SCHILLINGS Chloe	LUX
	BAYSUG Ecem	TUR
	PAPAGIANNAKI Alexandra	GRE
	POGOSYAN Gayane	EST

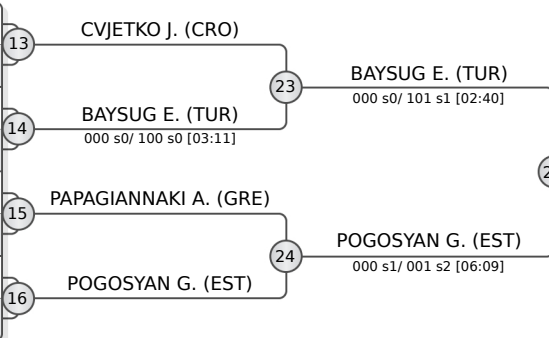

REPECHAGE

ONDEI S. (ITA)	29 ONDEI S. (ITA) [04:00]
GLUBIAK M. (POL)	30 OGNIVOVA E. (IJF) [01:24]
OGNIVOVA E. (IJF)	31 FOHOOU A. (SUI) [09:30]
POGOSYAN G. (EST)	32 BAYSUG E. (TUR) [04:00]
NILSSON I. (SWE)	33 ONDEI S. (ITA) [04:00]
	34 OGNIVOVA E. (IJF) [02:42]

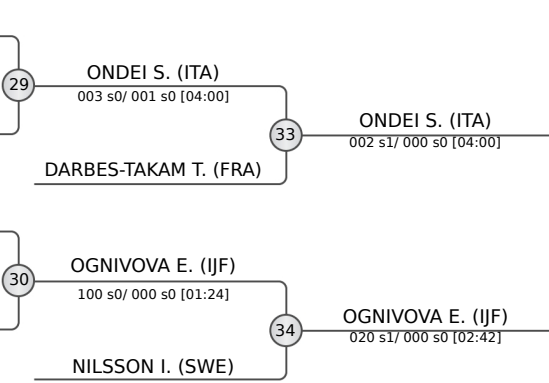

FINAL RESULTS		
1.	BAYSUG Ecem	TUR
2.	FOHOOU April Lynn	SUI
3.	ONDEI Serena	ITA
3.	OGNIVOVA Eva	IJF
5.	DARBES-TAKAM Teophila	FRA
5.	NILSSON Ingrid	SWE
7.	GLUBIAK Magda	POL
7.	POGOSYAN Gayane	EST

