



# European Senior Championships 2026 Individuals

Georgia, Tbilisi, 16-19 Apr 2026

## -81 kg

Seniors (38)

POOL A

|   |                          |     |
|---|--------------------------|-----|
| 1 | ARBUZOV Timur            | RUS |
| 2 | BONFERRONI Aurelien      | SUI |
| 3 | CHARNIAK Maksim          | BLR |
| 4 | TSOUTLASVILI Michail     | GRE |
| 5 | SVIDRAK Mykhailo         | UKR |
| 6 | NUNES DOS SANTOS Claudio | LUX |
| 7 | HEBIB Mustafa            | BIH |
| 8 | BIBITKO Itay             | ISR |
| 8 | ESPOSITO Antonio         | ITA |

|   |                       |
|---|-----------------------|
| 1 | ARBUZOV T. (RUS)      |
| 2 | BONFERRONI A. (SUI)   |
| 3 | CHARNIAK M. (BLR)     |
| 4 | TSOUTLASVILI M. (GRE) |
| 5 | SVIDRAK M. (UKR)      |
| 6 | HEBIB M. (BIH)        |
| 7 | BIBITKO I. (ISR)      |
| 8 | ESPOSITO A. (ITA)     |

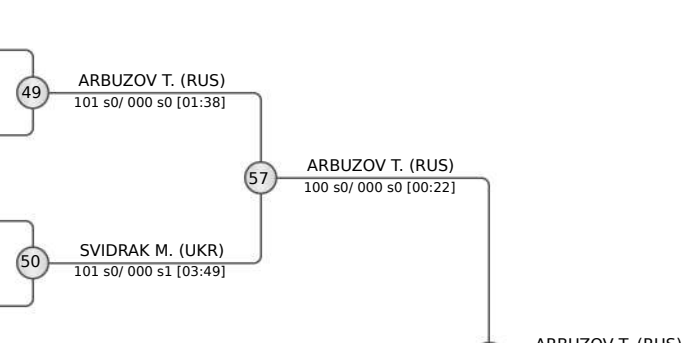

POOL B

|    |                    |     |
|----|--------------------|-----|
| 9  | ALBAYRAK Vedat     | TUR |
| 10 | STERPU Victor      | MDA |
| 11 | FASCHING Bernd     | AUT |
| 12 | GEORGAKIS Odysseas | CYP |
| 12 | SIMIN Mihajlo      | SRB |
| 13 | CASSE Matthias     | BEL |
| 14 | VALKOV Hristo      | BUL |
| 15 | CULLHAJ Indrit     | ALB |
| 16 | DIKAJEV Saad       | EST |
| 16 | TOTH Benedek       | HUN |

|    |                    |
|----|--------------------|
| 9  | ALBAYRAK V. (TUR)  |
| 10 | FASCHING B. (AUT)  |
| 11 | GEORGAKIS O. (CYP) |
| 12 | SIMIN M. (SRB)     |
| 13 | CASSE M. (BEL)     |
| 14 | VALKOV H. (BUL)    |
| 15 | DIKAJEV S. (EST)   |
| 16 | TOTH B. (HUN)      |

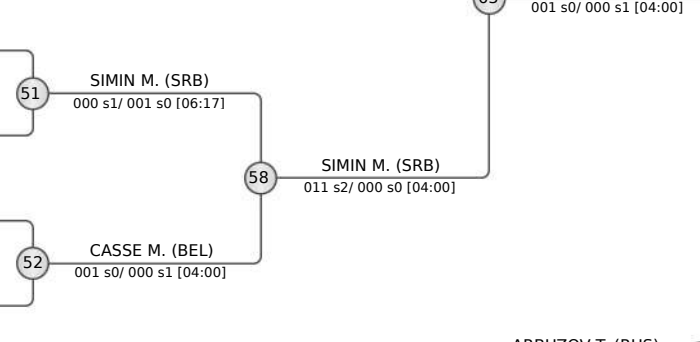

POOL C

|    |                      |     |
|----|----------------------|-----|
| 17 | GRIGALASHVILI Tato   | GEO |
| 18 | BORCHASHVILI Magamed | AUT |
| 19 | ZARAGKAS Aris        | GRE |
| 20 | VRENOZI Jon          | ALB |
| 21 | IHANAMAKI Eetu       | FIN |
| 22 | SULCA Adrian         | ROU |
| 23 | DUBOVIK Anton        | BLR |
| 24 | VITKAUSKAS Kestutis  | LTU |
| 24 | CASAGLIA Leonardo    | ITA |

|    |                        |
|----|------------------------|
| 17 | GRIGALASHVILI T. (GEO) |
| 18 | BORCHASHVILI M. (AUT)  |
| 19 | ZARAGKAS A. (GRE)      |
| 20 | VRENOZI J. (ALB)       |
| 21 | IHANAMAKI E. (FIN)     |
| 22 | SULCA A. (ROU)         |
| 23 | VITKAUSKAS K. (LTU)    |
| 24 | CASAGLIA L. (ITA)      |

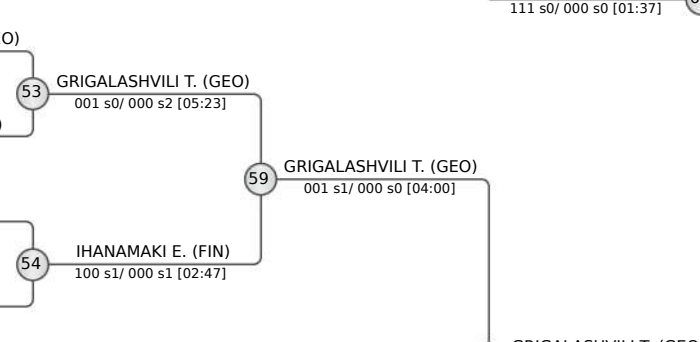

POOL D

|    |                    |     |
|----|--------------------|-----|
| 25 | TCKAEV Zelim       | AZE |
| 26 | HERKOVIC Nace      | SLO |
| 27 | KOLOBOV Vladyslav  | UKR |
| 28 | MLADY Petr         | CZE |
| 28 | GRAMATIKOV Georgi  | BUL |
| 29 | RAJABLI Omar       | AZE |
| 30 | NURKOVIC Jahja     | MNE |
| 31 | TASUEV Abdul-Kerim | RUS |
| 32 | PELIVAN Petru      | MDA |
| 32 | GRUJICIC Vasilije  | SRB |

|    |                     |
|----|---------------------|
| 25 | TCKAEV Z. (AZE)     |
| 26 | HERKOVIC N. (SLO)   |
| 27 | MLADY P. (CZE)      |
| 28 | GRAMATIKOV G. (BUL) |
| 29 | RAJABLI O. (AZE)    |
| 30 | TASUEV A. (RUS)     |
| 31 | PELIVAN P. (MDA)    |
| 32 | GRUJICIC V. (SRB)   |

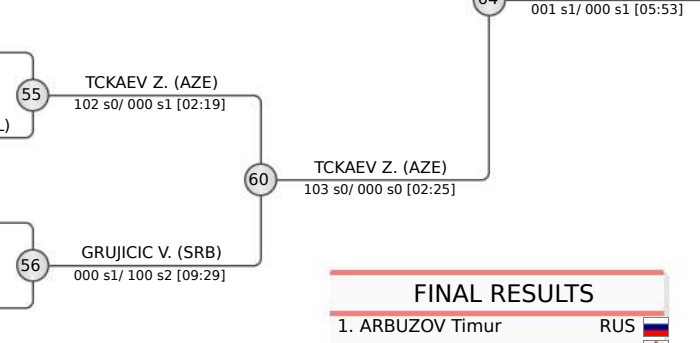

REPECHAGE

|                    |    |                    |
|--------------------|----|--------------------|
| SVIDRAK M. (UKR)   | 61 | CASSE M. (BEL)     |
| CASSE M. (BEL)     | 61 | TCKAEV Z. (AZE)    |
| IHANAMAKI E. (FIN) | 62 | IHANAMAKI E. (FIN) |
| GRUJICIC V. (SRB)  | 62 | SIMIN M. (SRB)     |

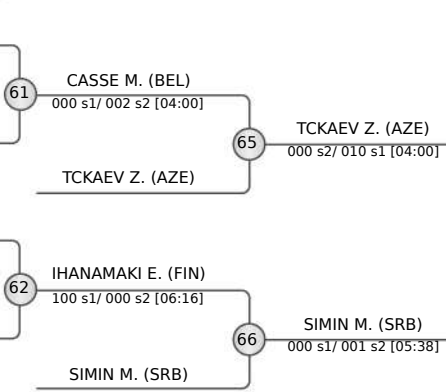

### FINAL RESULTS

|    |                    |     |
|----|--------------------|-----|
| 1. | ARBUZOV Timur      | RUS |
| 2. | GRIGALASHVILI Tato | GEO |
| 3. | TCKAEV Zelim       | AZE |
| 3. | SIMIN Mihajlo      | SRB |
| 5. | CASSE Matthias     | BEL |
| 5. | IHANAMAKI Eetu     | FIN |
| 7. | SVIDRAK Mykhailo   | UKR |
| 7. | GRUJICIC Vasilije  | SRB |





# European Senior Championships 2026 Individuals

Georgia, Tbilisi, 16-19 Apr 2026

## -90 kg

Seniors (38)

POOL A

|    |                          |     |
|----|--------------------------|-----|
| 1  | BEKAURI Lasha            | GEO |
| 2  | BEDEL Kenny Komí         | ITA |
| 3  | KALJULAJD Klen Kristofer | EST |
| 4  | LATISEV Mihail           | MDA |
| 5  | KLAMMERT David           | CZE |
| 6  | VARAPAYEU Yahor          | BLR |
| 7  | VISAN Vlad               | ROU |
| 8  | NIKCEVIC Stevan          | MNE |
| 9  | SCHRIEVER Lasse          | GER |
| 10 | SAFRANY Peter            | HUN |

|   |                    |    |                      |
|---|--------------------|----|----------------------|
| 1 | BEKAURI L. (GEO)   | 33 | BEKAURI L. (GEO)     |
| 2 | BEDEL K. (ITA)     | 34 | LATISEV M. (MDA)     |
| 3 | LATISEV M. (MDA)   | 35 | VARAPAYEU Y. (BLR)   |
| 4 | KLAMMERT D. (CZE)  | 36 | SCHRIEVER L. (GER)   |
| 5 | VARAPAYEU Y. (BLR) | 37 | MAJDOV N. (SRB)      |
| 6 | VISAN V. (ROU)     | 38 | MATHIEU A. (FRA)     |
| 7 | SCHRIEVER L. (GER) | 39 | SIVAN R. (ISR)       |
| 8 | SAFRANY P. (HUN)   | 40 | SCHARFETTER T. (AUT) |

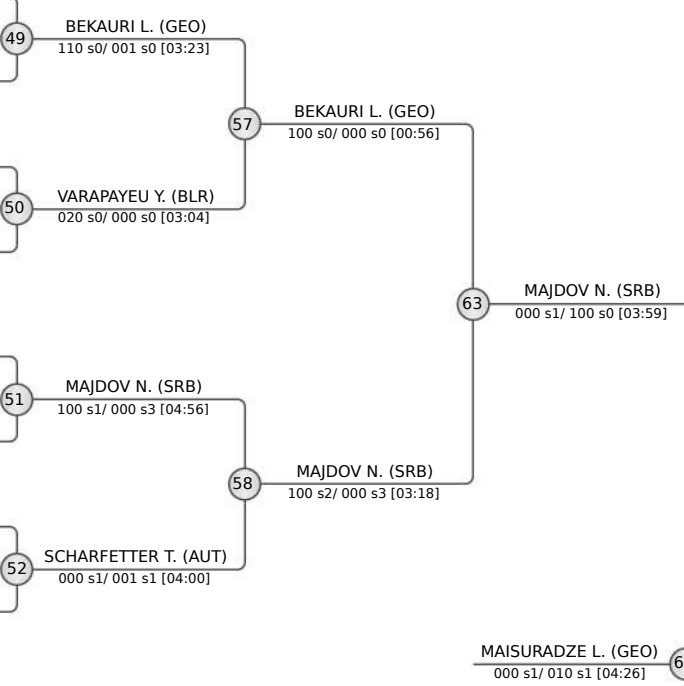

POOL B

|    |                            |     |
|----|----------------------------|-----|
| 9  | MAJDOV Nemanja             | SRB |
| 10 | SANTAMARIA RODRIGUEZ Aaron | ESP |
| 11 | PALEV Mariyan              | BUL |
| 12 | ANDONI Egor                | RUS |
| 13 | MATHIEU Alexis             | FRA |
| 14 | TSELIDIS Theodoros         | GRE |
| 15 | SIVAN Roy                  | ISR |
| 16 | SCHARFETTER Thomas         | AUT |
| 17 | CHRISTIAENS Noah           | BEL |

|    |                      |    |                        |
|----|----------------------|----|------------------------|
| 9  | MAJDOV N. (SRB)      | 41 | MAISURADZE L. (GEO)    |
| 10 | PALEV M. (BUL)       | 42 | SOGENOV I. (SRB)       |
| 11 | ANDONI E. (RUS)      | 43 | IVANOV I. (BUL)        |
| 12 | MATHIEU A. (FRA)     | 44 | NASCHCHO I. (AUT)      |
| 13 | TSELIDIS T. (GRE)    | 45 | CRET A. (ROU)          |
| 14 | SIVAN R. (ISR)       | 46 | MYLONELIS A. (GRE)     |
| 15 | SCHARFETTER T. (AUT) | 47 | NGAYAP HAMBOU M. (FRA) |
| 16 | CHRISTIAENS N. (BEL) | 48 | GHIMBOVSCHI V. (MDA)   |

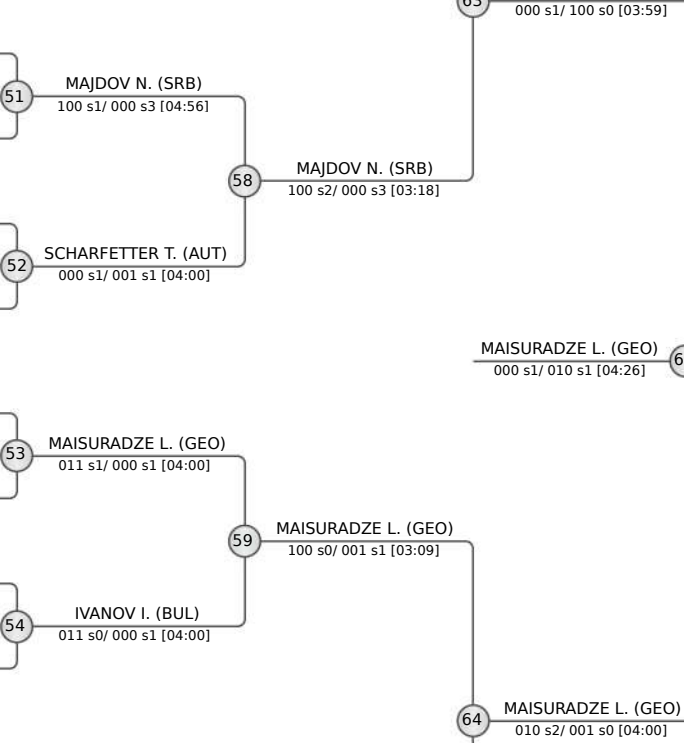

POOL C

|    |                          |     |
|----|--------------------------|-----|
| 17 | MAISURADZE Luka          | GEO |
| 18 | DUYCK Jarne              | BEL |
| 19 | FRIDMAN ZILBERSTEIN Reem | ISR |
| 20 | MILETIC Toni             | BIH |
| 21 | SOGENOV Islam            | SRB |
| 22 | KOPECKY Adam             | CZE |
| 23 | SHYMBALIOU Andrei        | BLR |
| 24 | IVANOV Ivaylo            | BUL |
| 25 | NASCHCHO Issa            | AUT |
| 26 | NERPEL Gergely           | HUN |

|    |                              |    |                        |
|----|------------------------------|----|------------------------|
| 17 | MAISURADZE L. (GEO)          | 49 | BEKAURI L. (GEO)       |
| 18 | FRIDMAN ZILBERSTEIN R. (ISR) | 50 | VARAPAYEU Y. (BLR)     |
| 19 | MILETIC T. (BIH)             | 51 | MAJDOV N. (SRB)        |
| 20 | SOGENOV I. (SRB)             | 52 | SCHARFETTER T. (AUT)   |
| 21 | KOPECKY A. (CZE)             | 53 | MAISURADZE L. (GEO)    |
| 22 | IVANOV I. (BUL)              | 54 | IVANOV I. (BUL)        |
| 23 | NASCHCHO I. (AUT)            | 55 | CRET A. (ROU)          |
| 24 | NERPEL G. (HUN)              | 56 | NGAYAP HAMBOU M. (FRA) |

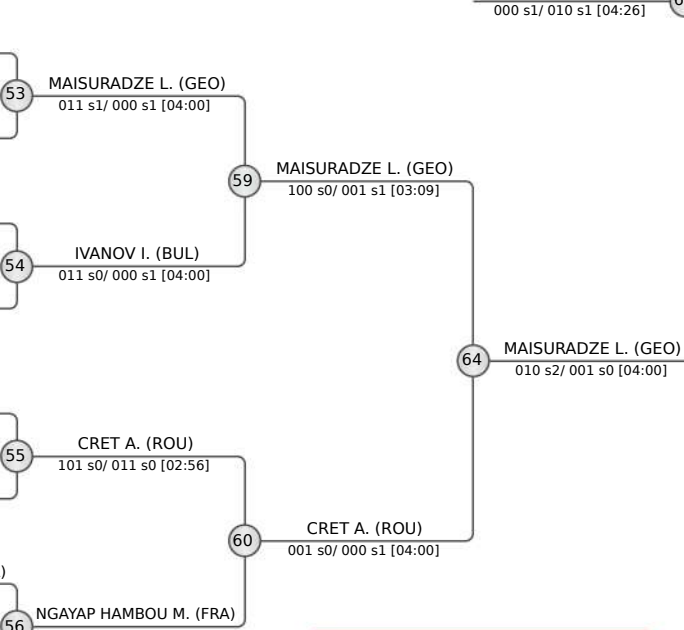

POOL D

|    |                           |     |
|----|---------------------------|-----|
| 25 | FATIYEV Murad             | AZE |
| 26 | CRET Alex                 | ROU |
| 27 | BARTO Alex                | SVK |
| 28 | MYLONELIS Athanasios      | GRE |
| 29 | SLYTERIS Augustas         | LTU |
| 30 | NGAYAP HAMBOU Maxime-Gael | FRA |
| 31 | RAICEVIC Novo             | MNE |
| 32 | GHIMBOVSCHI Vadim         | MDA |
| 33 | LENZ Johann               | GER |

|    |                        |    |                        |
|----|------------------------|----|------------------------|
| 25 | FATIYEV M. (AZE)       | 57 | BEKAURI L. (GEO)       |
| 26 | CRET A. (ROU)          | 58 | MAJDOV N. (SRB)        |
| 27 | MYLONELIS A. (GRE)     | 59 | MAISURADZE L. (GEO)    |
| 28 | SLYTERIS A. (LTU)      | 60 | CRET A. (ROU)          |
| 29 | NGAYAP HAMBOU M. (FRA) | 61 | SCHARFETTER T. (AUT)   |
| 30 | RAICEVIC N. (MNE)      | 62 | NGAYAP HAMBOU M. (FRA) |
| 31 | GHIMBOVSCHI V. (MDA)   | 63 | MAJDOV N. (SRB)        |
| 32 | LENZ J. (GER)          | 64 | MAISURADZE L. (GEO)    |

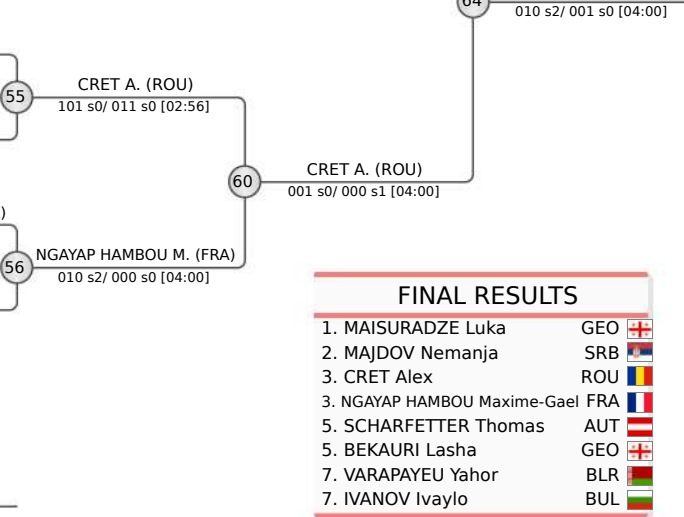

REPECHAGE

|    |                        |    |                  |
|----|------------------------|----|------------------|
| 61 | SCHARFETTER T. (AUT)   | 65 | CRET A. (ROU)    |
| 62 | NGAYAP HAMBOU M. (FRA) | 66 | BEKAURI L. (GEO) |

|    |                        |    |                  |
|----|------------------------|----|------------------|
| 61 | SCHARFETTER T. (AUT)   | 65 | CRET A. (ROU)    |
| 62 | NGAYAP HAMBOU M. (FRA) | 66 | BEKAURI L. (GEO) |

| FINAL RESULTS |                           |     |
|---------------|---------------------------|-----|
| 1.            | MAISURADZE Luka           | GEO |
| 2.            | MAJDOV Nemanja            | SRB |
| 3.            | CRET Alex                 | ROU |
| 3.            | NGAYAP HAMBOU Maxime-Gael | FRA |
| 5.            | SCHARFETTER Thomas        | AUT |
| 5.            | BEKAURI Lasha             | GEO |
| 7.            | VARAPAYEU Yahor           | BLR |
| 7.            | IVANOV Ivaylo             | BUL |





# European Senior Championships 2026 Individuals

Georgia, Tbilisi, 16-19 Apr 2026

## -70 kg

Seniors (35)

### POOL A

|     |                   |
|-----|-------------------|
| CRO | CVJETKO Lara      |
| LTU | PILECKAITE Ugne   |
| SRB | ANDRIC Aleksandra |
| SWE | NILSSON Ingrid    |
| ITA | PEDROTTI Irene    |
| GEO | GULBANI Nino      |
| GER | BOCK Samira       |
| RUS | TAIMAZOVA Madina  |
| AUT | POLLERES Michaela |

|   |                     |    |                        |
|---|---------------------|----|------------------------|
| 1 | CVJETKO L. (CRO)    | 33 | CVJETKO L. (CRO)       |
| 2 | PILECKAITE U. (LTU) |    | 100 s0/ 000 s3 [03:21] |
| 3 | ANDRIC A. (SRB)     | 34 | ANDRIC A. (SRB)        |
| 4 | NILSSON I. (SWE)    |    | 021 s0/ 000 s0 [02:18] |
| 5 | PEDROTTI I. (ITA)   | 35 | PEDROTTI I. (ITA)      |
| 6 | GULBANI N. (GEO)    |    | 100 s1/ 000 s3 [05:41] |
| 7 | TAIMAZOVA M. (RUS)  | 36 | TAIMAZOVA M. (RUS)     |
| 8 | POLLERES M. (AUT)   |    | 001 s1/ 000 s0 [04:00] |

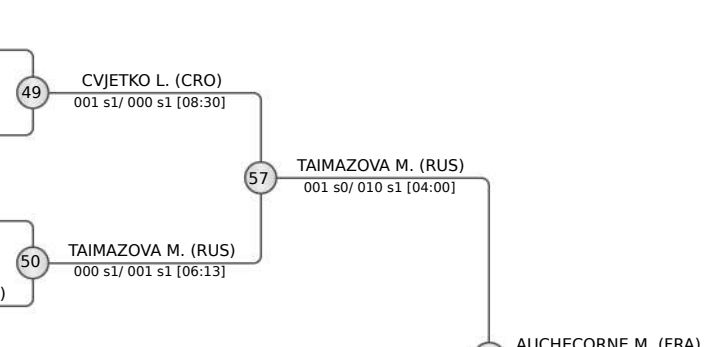

### POOL B

|     |                       |
|-----|-----------------------|
| ESP | TSUNODA ROUSTANT Ai   |
| BIH | SAMARDZIC Aleksandra  |
| POL | KOWALEWSKA Aleksandra |
| CZE | ZARYBNICKA Lucie      |
| SUI | VETTERLI Gioia        |
| ITA | STANGHERLIN Giorgia   |
| UKR | TSIMKO OIha           |
| FRA | AUCHECORNE Melkia     |
| NED | VAN DIJKE Sanne       |

|    |                           |    |                           |
|----|---------------------------|----|---------------------------|
| 9  | TSUNODA ROUSTANT A. (ESP) | 37 | TSUNODA ROUSTANT A. (ESP) |
| 10 | SAMARDZIC A. (BIH)        |    | 100 s0/ 000 s1 [04:56]    |
| 11 | KOWALEWSKA A. (POL)       | 38 | VETTERLI G. (SUI)         |
| 12 | ZARYBNICKA L. (CZE)       |    | 010 s0/ 000 s2 [04:58]    |
| 13 | STANGHERLIN G. (ITA)      | 39 | STANGHERLIN G. (ITA)      |
| 14 | TSIMKO O. (UKR)           |    | 001 s1/ 000 s1 [06:14]    |
| 15 | AUCHECORNE M. (FRA)       | 40 | AUCHECORNE M. (FRA)       |
| 16 | VAN DIJKE S. (NED)        |    | 001 s2/ 000 s1 [05:20]    |

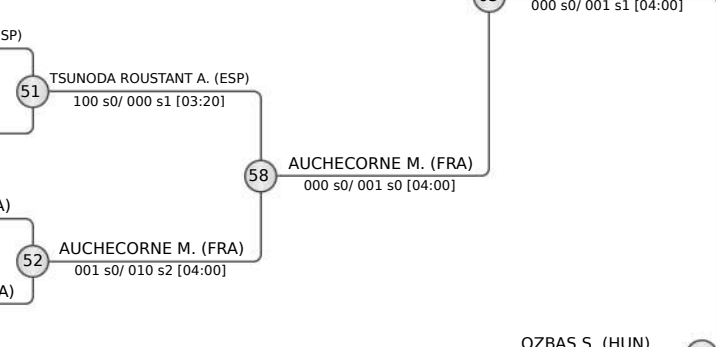

### POOL C

|     |                        |
|-----|------------------------|
| HUN | OZBAS Szofi            |
| GEO | TCHANTURIA Mariam      |
| ISR | GOSHEN Maya            |
| AZE | AGHAYEVA Sudaba        |
| GBR | PETERSEN POLLARD Kelly |
| GRE | ELTSIDOU Elisavet      |
| BUL | JAAFAR Nadie           |
| NED | DE VOOGD Margit        |
| POL | SOBIERAJSKA Katarzyna  |

|    |                           |    |                        |
|----|---------------------------|----|------------------------|
| 17 | OZBAS S. (HUN)            | 41 | OZBAS S. (HUN)         |
| 18 | TCHANTURIA M. (GEO)       |    | 010 s0/ 000 s2 [04:00] |
| 19 | AGHAYEVA S. (AZE)         | 42 | AGHAYEVA S. (AZE)      |
| 20 | PETERSEN POLLARD K. (GBR) |    | 000 s0/ 001 s2 [04:00] |
| 21 | ELTSIDOU E. (GRE)         | 43 | ELTSIDOU E. (GRE)      |
| 22 | JAAFAR N. (BUL)           |    | 100 s0/ 000 s0 [01:59] |
| 23 | DE VOOGD M. (NED)         | 44 | DE VOOGD M. (NED)      |
| 24 | SOBIERAJSKA K. (POL)      |    | 001 s0/ 000 s1 [04:19] |

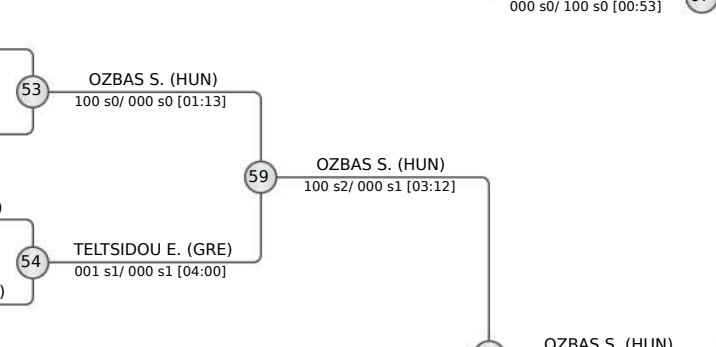

### POOL D

|     |                   |
|-----|-------------------|
| SWE | ERIKSSON Ida      |
| SRB | CAKAREVIC Jovana  |
| CZE | SKALSKA Anna      |
| SLO | KOREN Nika        |
| SUI | FOHOOU April Lynn |
| GER | POHL Dena         |
| POR | TIMO Barbara      |
| TUR | ORUC Sinem        |

|    |                    |    |                        |
|----|--------------------|----|------------------------|
| 25 | ERIKSSON I. (SWE)  | 45 | ERIKSSON I. (SWE)      |
| 26 | CAKAREVIC J. (SRB) |    | 100 s2/ 000 s3 [04:17] |
| 27 | SKALSKA A. (CZE)   | 46 | SKALSKA A. (CZE)       |
| 28 | KOREN N. (SLO)     |    | 001 s1/ 000 s0 [04:00] |
| 29 | FOHOOU A. (SUI)    | 47 | FOHOOU A. (SUI)        |
| 30 | POHL D. (GER)      |    | 002 s2/ 000 s2 [04:00] |
| 31 | TIMO B. (POR)      | 48 | TIMO B. (POR)          |
| 32 | ORUC S. (TUR)      |    | 100 s0/ 000 s0 [02:00] |

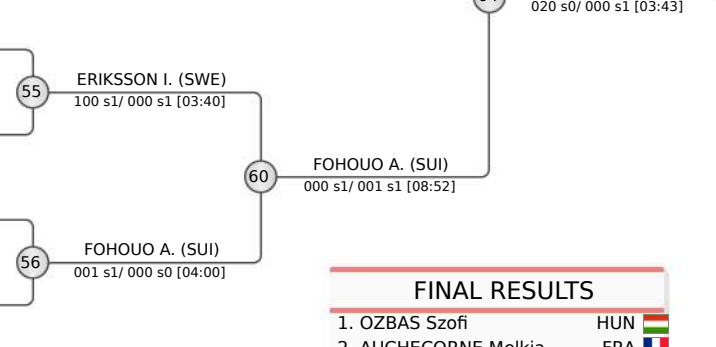

### REPECHAGE

|                           |    |                        |
|---------------------------|----|------------------------|
| CVJETKO L. (CRO)          | 61 | CVJETKO L. (CRO)       |
| TSUNODA ROUSTANT A. (ESP) |    | 100 s1/ 000 s3 [04:44] |
| ELTSIDOU E. (GRE)         | 62 | ELTSIDOU E. (GRE)      |
| ERIKSSON I. (SWE)         |    | 100 s0/ 000 s2 [00:56] |
| TAIMAZOVA M. (RUS)        | 66 | TAIMAZOVA M. (RUS)     |
|                           |    | 000 s0/ 020 s1 [01:23] |

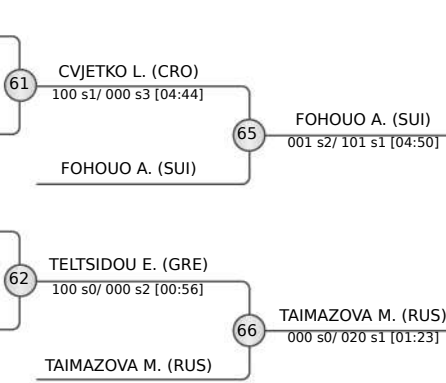

### FINAL RESULTS

|    |                     |     |
|----|---------------------|-----|
| 1. | OZBAS Szofi         | HUN |
| 2. | AUCHECORNE Melkia   | FRA |
| 3. | FOHOOU April Lynn   | SUI |
| 4. | TAIMAZOVA Madina    | RUS |
| 5. | CVJETKO Lara        | CRO |
| 5. | ELTSIDOU Elisavet   | GRE |
| 7. | TSUNODA ROUSTANT Ai | ESP |
| 7. | ERIKSSON Ida        | SWE |

