



Riga Cadet European Cup 2023

Latvia, Riga, 21-22 Oct 2023

-73 kg

Cadets (41)

POOL A

	DIKAJEV Saad	EST
	RUDENKO Tymofii	UKR
	CEKAITIS Vitoldas	LTU
	RASMUSSEN Maite	DEN
	ZVANERS Daniels	LAT
	MEHDIYEV Ahmad	AZE
	BRIGMANIS-BRIGIS Ernests	LAT
	MUSZYNSKI Jakub	POL
	LEMOs Andre	POR
	ZALEVSKIS Fjodors	LAT

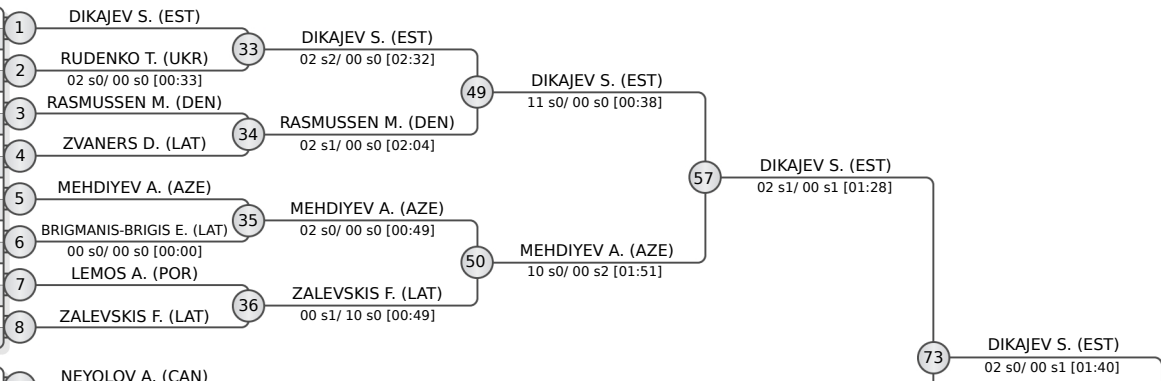

POOL B

	NEYOLOV Artem	CAN
	AVDEJEVS Aleksandrs	LAT
	DABROWSKI Norbert	POL
	BLYZNIUK Tymur	UKR
	MOZGO Dautartas	LTU
	KASESALU Christian-Marcus	EST
	RACKA Norbertas	LTU
	JENSEN Maithe	DEN
	JAPINS Raivis	LAT
	KOBYLINSKI Jakub	POL

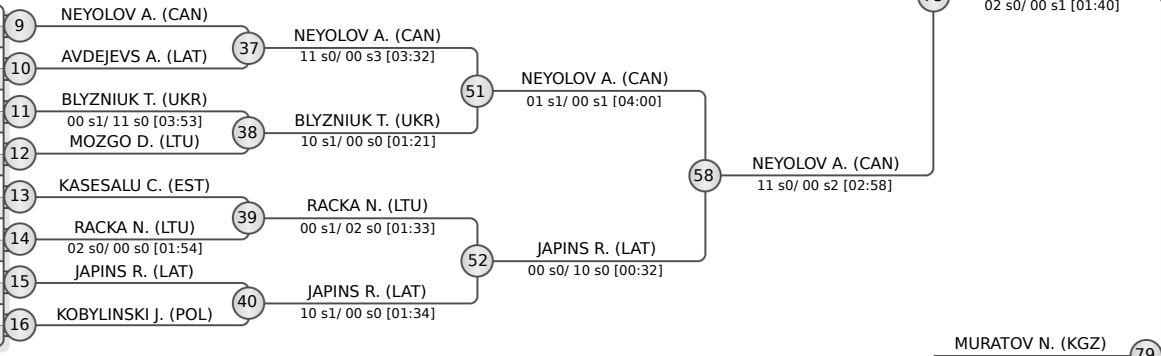

POOL C

	MURATOV Nurmukhammed	KGZ
	IBADLI Jasur	AZE
	BETKOWSKI Jeremiasz	POL
	DUBICKIJ Michail	LTU
	KULLO Tits	LAT
	LINDQUIST Sebastian	DEN
	ZARINS Ricards	LAT
	GORUN Volodymyr	UKR
	MIRIJEV Paerviz	EST
	LOVANG Vidar	SWE
	JAKAS Eimantas	LTU

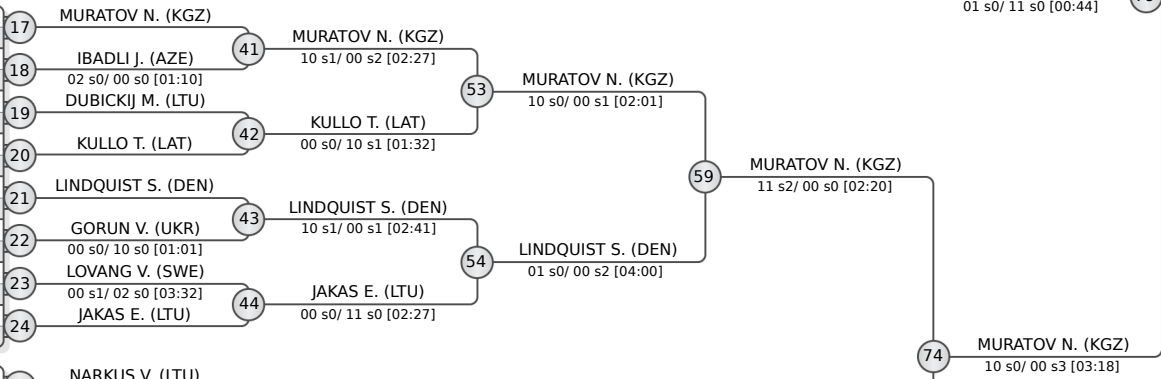

POOL D

	NARKUS Vygidras	LTU
	ANDERSEN Simon	DEN
	PARKHOMENKO Maksym	UKR
	BASMAKOVs Illarions	LAT
	BJOERNSTROEM Andreas	NOR
	SAAR Karl	EST
	TALIS Daniels	LAT
	LUDZIA Jan Kanty	POL
	PURPISS Nikass	LAT
	BOJAROVIC Artur	LTU

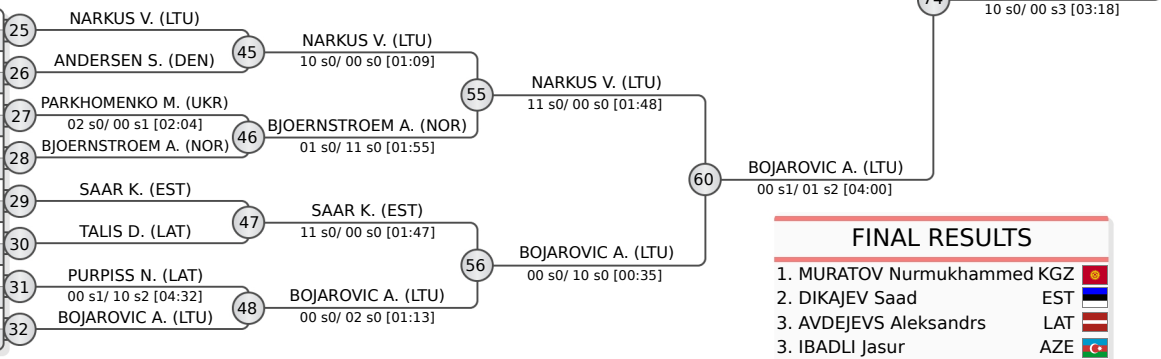

FINAL RESULTS		
1.	MURATOV Nurmukhammed	KGZ
2.	DIKAJEV Saad	EST
3.	AVDEJEVS Aleksandrs	LAT
3.	IBADLI Jasur	AZE
5.	BOJAROVIC Artur	LTU
5.	NEYOLOV Artem	CAN
7.	MEHDIYEV Ahmad	AZE
7.	NARKUS Vygidras	LTU

REPECHAGE

	RUDENKO T. (UKR)	61	RUDENKO T. (UKR)	65	RUDENKO T. (UKR)	69	MEHDIYEV A. (AZE)	75	AVDEJEVS A. (LAT)	77	AVDEJEVS A. (LAT)
	AVDEJEVS A. (LAT)	62	AVDEJEVS A. (LAT)	66	AVDEJEVS A. (LAT)	70	AVDEJEVS A. (LAT)	75	AVDEJEVS A. (LAT)	77	AVDEJEVS A. (LAT)
	IBADLI J. (AZE)	63	IBADLI J. (AZE)	67	IBADLI J. (AZE)	71	IBADLI J. (AZE)	76	IBADLI J. (AZE)	78	IBADLI J. (AZE)
	PURPISS N. (LAT)	64	PURPISS N. (LAT)	68	SAAR K. (EST)	72	NARKUS V. (LTU)	76	IBADLI J. (AZE)	78	IBADLI J. (AZE)

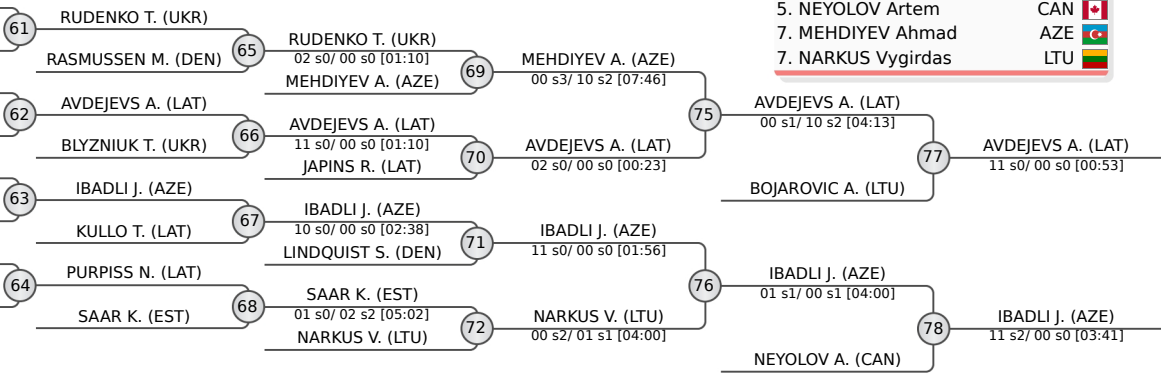



Riga Cadet European Cup 2023

Latvia, Riga, 21-22 Oct 2023

-81 kg

Cadets (27)

POOL A

	EYVAZLI Huseyn	AZE
	TOMASZKIEWICZ Justus	POL
	BUMAZKINS Jelisejs	LAT
	GUSIC Imran	BIH
	BUJUKLIEV Alex	SWE
	GENEVICIUS Tajus	LTU
	KOMIN Kirill	EST

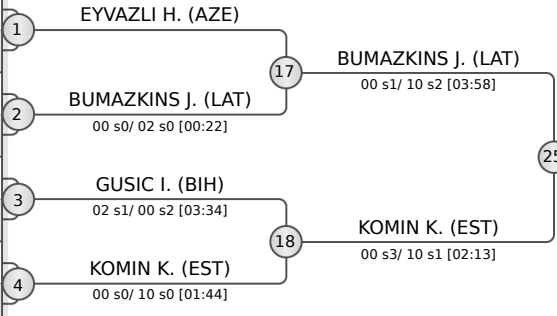

POOL B

	SWIDWA Robert	POL
	GAZIMAMMADOV Ali	AZE
	SOLIANYK Mykhailo	UKR
	PILECKAS Aidas	LTU
	GOLOVATJUKS Artjoms	LAT
	DOMBERG TõNis	EST

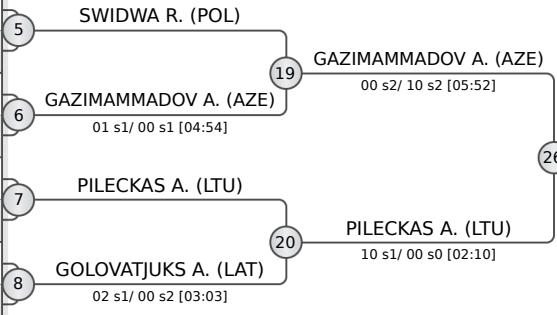

POOL C

	KRYVYTSKYI Tigran	CAN
	SIERAKOWSKI Mateusz	POL
	VITAL Frederico	POR
	JOLKIN Nikita	EST
	SPRINGIS Jevgenijs	LAT
	ZILYS Tomas	LTU
	ABBASOV Mehdi	AZE

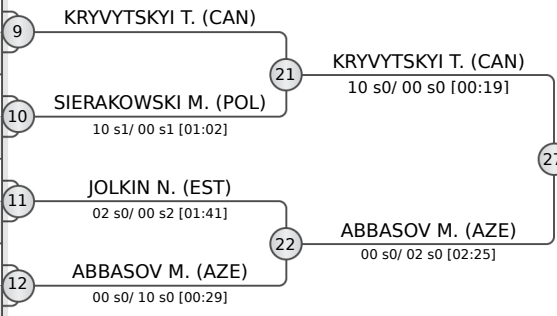

POOL D

	JACENKO Arturs	LAT
	PASZEK Damian	POL
	KOCH Fabian	SWE
	DJINKIC Ivano	BIH
	NILLER Jaan	EST
	JEPPESEN Matthaues	DEN
	POPOVS Maksims	LAT

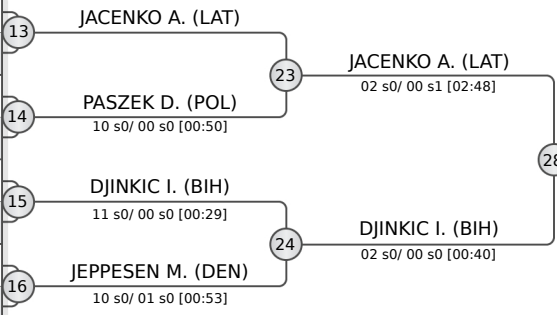

REPECHAGE

TOMASZKIEWICZ J. (POL)	29 EYVAZLI H. (AZE)	33 KOMIN K. (EST)
EYVAZLI H. (AZE)	SOLIANYK M. (UKR)	34 SOLIANYK M. (UKR)
SOLIANYK M. (UKR)	SWIDWA R. (POL)	35 ABBASOV M. (AZE)
SWIDWA R. (POL)	SIERAKOWSKI M. (POL)	36 JACENKO A. (LAT)
SIERAKOWSKI M. (POL)	NILLER J. (EST)	
NILLER J. (EST)	JEPPESEN M. (DEN)	
JEPPESEN M. (DEN)		

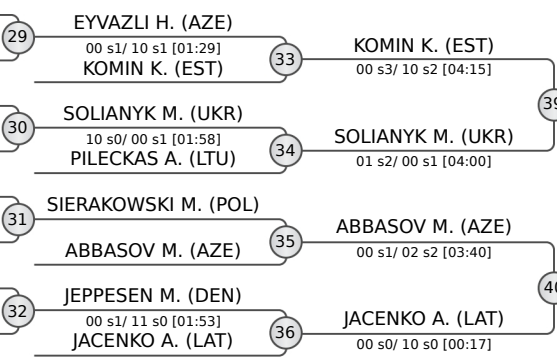

FINAL RESULTS	
1. DJINKIC Ivano	BIH
2. GAZIMAMMADOV Ali	AZE
3. KRYVYTSKYI Tigran	CAN
3. ABBASOV Mehdi	AZE
5. SOLIANYK Mykhailo	UKR
7. BUMAZKINS Jelisejs	LAT
7. KOMIN Kirill	EST
7. JACENKO Arturs	LAT





Riga Cadet European Cup 2023

Latvia, Riga, 21-22 Oct 2023

-90 kg

Cadets (13)

POOL A

	WACKO Mateusz	POL
	GENYS Majus	LTU
	USIN Huko Pärtel	EST

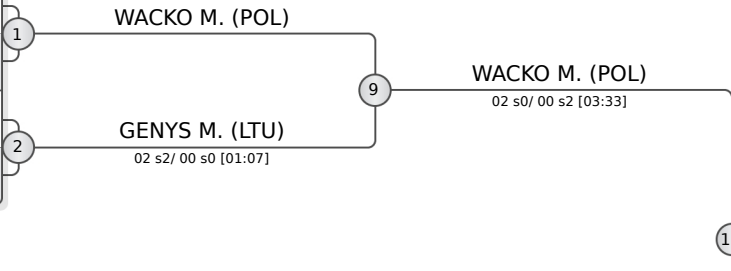

POOL B

	SPYRYDONOV Daniil	UKR
	ALTENA Thijs	NED
	GROMOV Daniils	LAT
	MILICEVIC Ivan	BIH

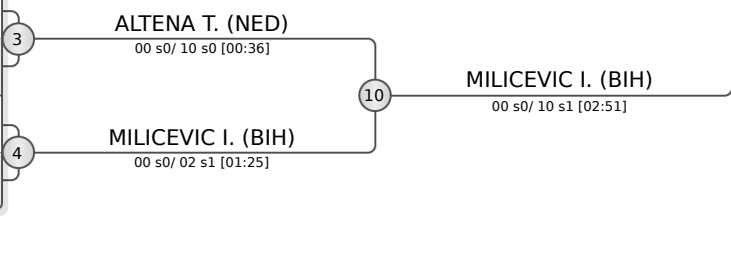

POOL C

	AFANASJEVS Nikita	LAT
	LEBID Dmytro	UKR
	DA CRUZ Matteo	LUX

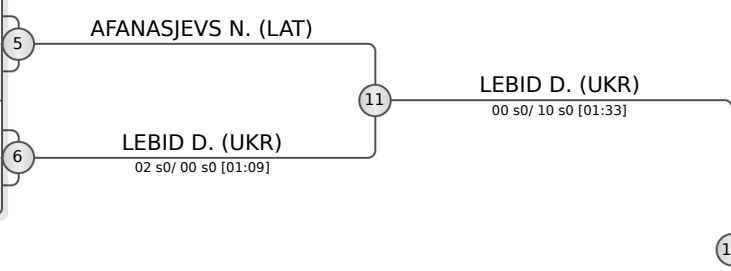

POOL D

	SAMOILOV Arkadii	UKR
	ROHDE Quint	NED
	SOUSA Henrique	POR

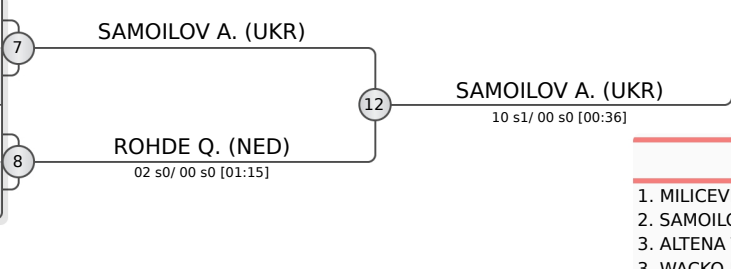

FINAL RESULTS		
1.	MILICEVIC Ivan	BIH
2.	SAMOILOV Arkadii	UKR
3.	ALTENA Thijs	NED
3.	WACKO Mateusz	POL
5.	LEBID Dmytro	UKR
5.	AFANASJEVS Nikita	LAT
7.	GENYS Majus	LTU
7.	ROHDE Quint	NED

REPECHAGE

GENYS M. (LTU)	13
GROMOV D. (LAT)	14
ALTENA T. (NED)	15
DA CRUZ M. (LUX)	16
AFANASJEVS N. (LAT)	17
ROHDE Q. (NED)	18

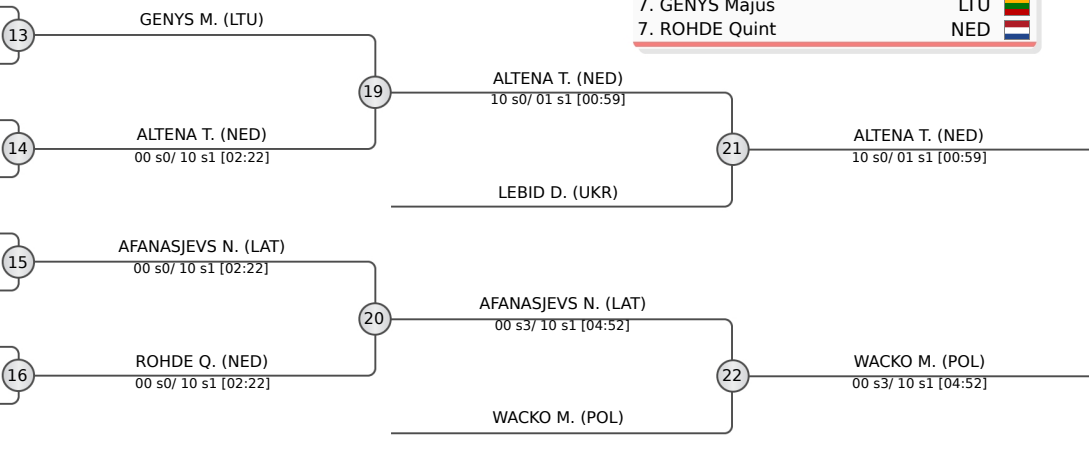



Riga Cadet European Cup 2023

Latvia, Riga, 21-22 Oct 2023

+ 90 kg

Cadets (17)

POOL A

	MASAK Marek-Adrian	EST
	RAPKEVICIUS Rokas	LTU
	KLIMCIAUSKAS Antanas	LTU
	BLAZEVICIS Artemijs	LAT

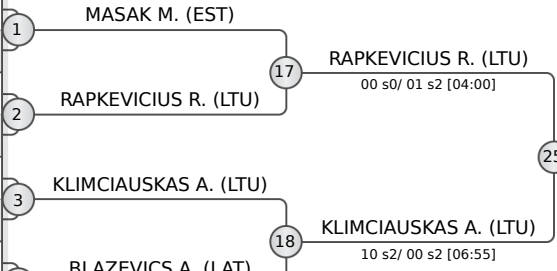

POOL B

	SALHALOV Davyd	UKR
	AKHUNDOV Subhan	AZE
	PAULASKAS Lukas	LTU
	KHACHATRYAN Anton	POL

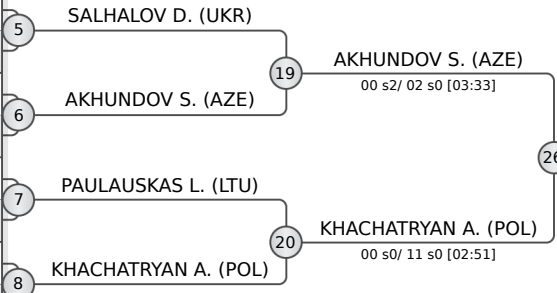

POOL C

	SAMADLI Rasul	AZE
	NESTEROVS Vadims	LAT
	FESENKO Oleh	UKR
	EENMA Siim	EST
	TAURA Patrikas	LTU

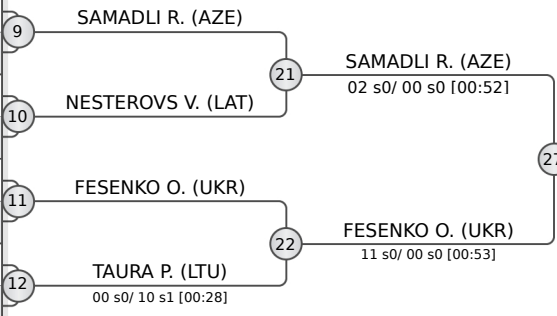

POOL D

	RISUKHIN Bohdan	UKR
	MASTEIKA Titas	LTU
	STREMAUSKAS Mykolas	LTU
	CHAMERSKI Daniel	POL

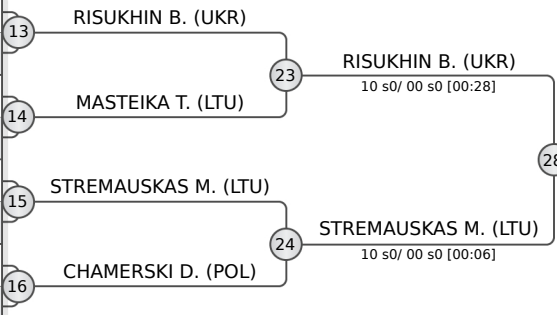

REPECHAGE

MASAK M. (EST)	29	MASAK M. (EST)	33
SALHALOV D. (UKR)	30	SALHALOV D. (UKR)	34
NESTEROVS V. (LAT)	31	FESENKO O. (UKR)	35
CHAMERSKI D. (POL)	32	CHAMERSKI D. (POL)	36

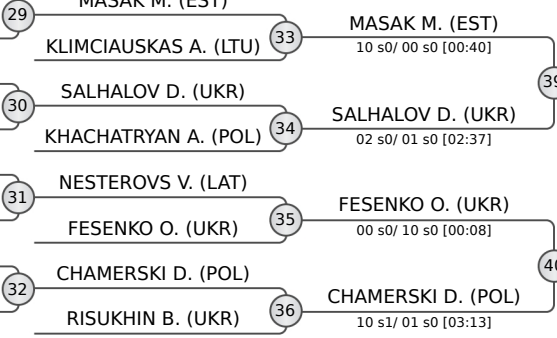

AKHUNDOV S. (AZE) 43
01 s1/ 00 s1 [04:00]

SAMADLI R. (AZE) 38
10 s1/ 00 s1 [02:34]

FINAL RESULTS	
1.	AKHUNDOV Subhan AZE
2.	SAMADLI Rasul AZE
3.	MASAK Marek-Adrian EST
3.	RAPKEVICIUS Rokas LTU
5.	STREMAUSKAS Mykolas LTU
5.	FESENKO Oleh UKR
7.	SALHALOV Davyd UKR
7.	CHAMERSKI Daniel POL





Riga Cadet European Cup 2023

Latvia, Riga, 21-22 Oct 2023

-57 kg

Cadets (16)

POOL A

	BIELAWSKA Emilia	POL
	AVDIC Leila	SWE
	HAKSO Laura	FIN
	MAROZAITE Rugile	LTU

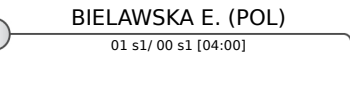
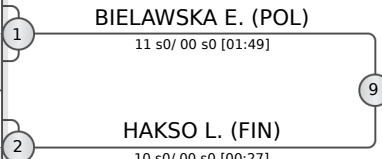

POOL B

	RASIMENOKA Marija	LAT
	KOMODOWSKI Ingrid	DEN
	SOTNYK Viktoriia	UKR
	STASKIEWICZ Anna	POL

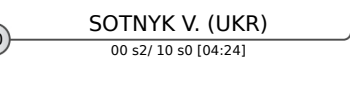
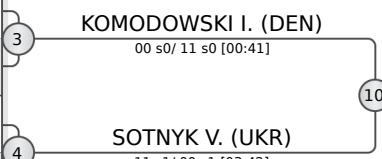

POOL C

	TKACHENKO Alyssa	CAN
	MACOVEI Laura	POR
	BOZHKO Yelyzaveta	UKR
	KERGALVE Viktorija	LAT

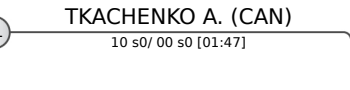
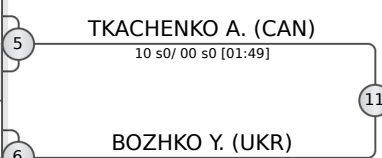

POOL D

	SKERYTE Ugne	LTU
	MARKOVICSOVA Emma	SVK
	GULBIANI Nana	GEO
	ZABLOCKA Krystyna	POL

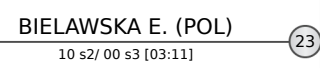
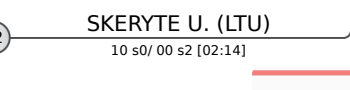
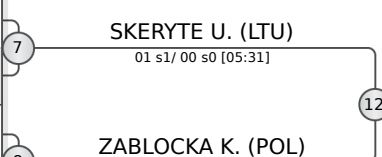

FINAL RESULTS		
1.	BIELAWSKA Emilia	POL
2.	SKERYTE Ugne	LTU
3.	TKACHENKO Alyssa	CAN
3.	SOTNYK Viktoriia	UKR
5.	KOMODOWSKI Ingrid	DEN
5.	MACOVEI Laura	POR
7.	HAKSO Laura	FIN
7.	MARKOVICSOVA Emma	SVK

REPECHAGE

AVDIC L. (SWE)	13	HAKSO L. (FIN) 00 s0/ 02 s0 [01:17]
HAKSO L. (FIN)	14	KOMODOWSKI I. (DEN) 00 s0/ 10 s0 [01:53]
STASKIEWICZ A. (POL)	15	MACOVEI L. (POR) 00 s0/ 10 s0 [01:53]
KOMODOWSKI I. (DEN)	16	MARKOVICSOVA E. (SVK) 00 s0/ 10 s0 [01:53]
MACOVEI L. (POR)	17	MARKOVICSOVA E. (SVK) 00 s0/ 10 s0 [01:53]
BOZHKO Y. (UKR)	18	ZABLOCKA K. (POL)
MARKOVICSOVA E. (SVK)	19	
ZABLOCKA K. (POL)	20	

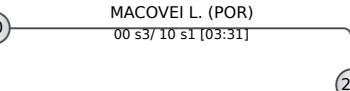
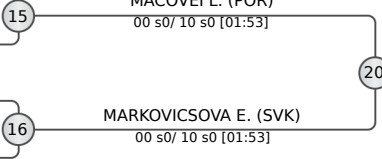
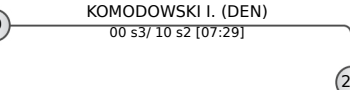
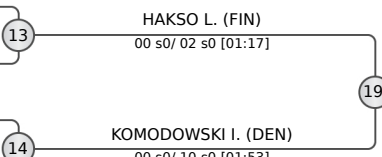



Riga Cadet European Cup 2023

Latvia, Riga, 21-22 Oct 2023

-63 kg

Cadets (18)

POOL A

	KUCHAR Varvara	LTU
	HANNA Zaitseva	POL
	LIPPUS Henrietta	EST
	NATELAURI Mariam	GEO
	NARVA Ada-Alexia	FIN

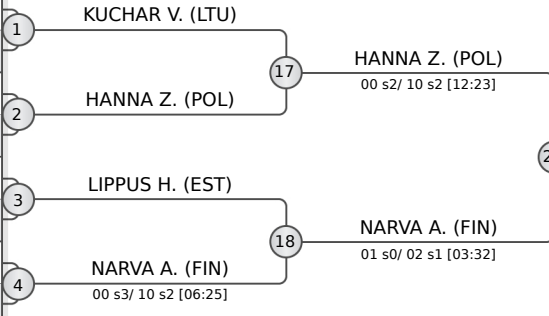

POOL B

	BUNTIC Ivana	BIH
	BOCCADORO Julia	NOR
	PONOMARJOVA Sofija	LAT
	KARDASH Kristina	ITA

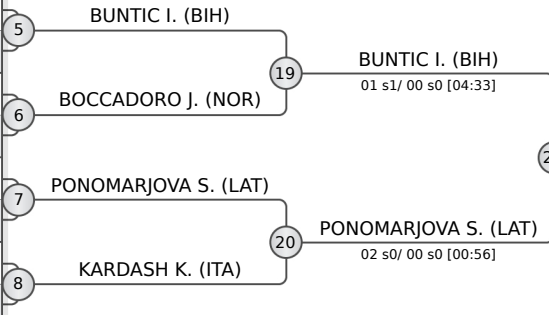

POOL C

	PTASINSKA Amelia	POL
	JOHANSSON Ronja	SWE
	KUOSMANEN Jenna	FIN
	BERNARDO Sofia	POR
	OBOJES Laura	ITA

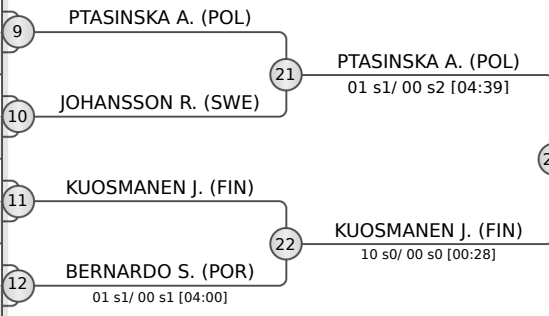

POOL D

	NOERSKOV Mai	DEN
	PIETRZAK Gabriela	POL
	EHMSEN Karen	DEN
	BOICHENKO Daria	UKR

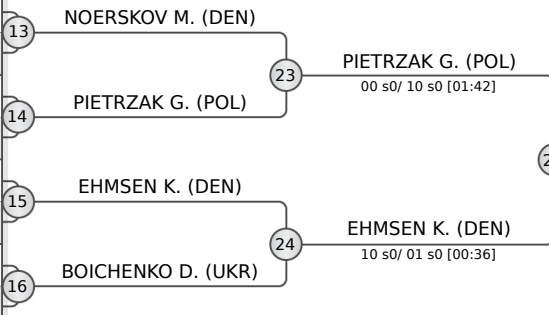

REPECHAGE

	KUCHAR V. (LTU)	29
	KARDASH K. (ITA)	30
	JOHANSSON R. (SWE)	31
	NOERSKOV M. (DEN)	32
	NARVA A. (FIN)	33
	BUNTIC I. (BIH)	34
	KUOSMANEN J. (FIN)	35
	EHMSEN K. (DEN)	36

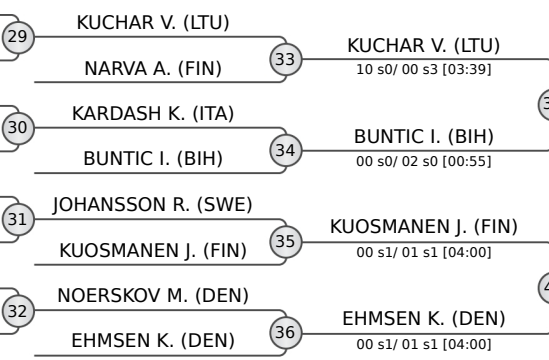

FINAL RESULTS	
1.	HANNA Zaitseva
2.	PTASINSKA Amelia
3.	PIETRZAK Gabriela
3.	KUOSMANEN Jenna
5.	BUNTIC Ivana
7.	PONOMARJOVA Sofija
7.	KUCHAR Varvara
7.	EHMSEN Karen

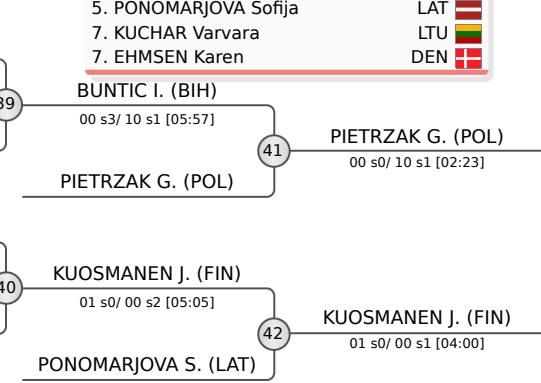

POOL A

	NAVICKAITE Marta	LTU
	ROBAKIDZE Keti	GEO
	PIKOSZ Nicole	POL

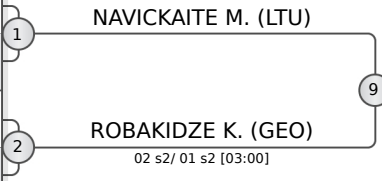

POOL B

	RAKALOVICIUTE Ieva	LTU
	VAN DEN HIL Danielle	NED
	AHIEIEVA Anastasiia	UKR
	KIKOLSKA Maja	POL



POOL C

	STALIONYTE Paulina	LTU
	SZYMANIAK Gabriela	POL
	ISAJEVA Anastasija	LAT

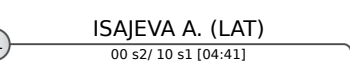
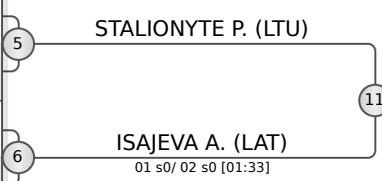

POOL D

	SKORUPIŃSKA Martyna	POL
	JOHANNESEN Eva	NOR
	STRAK Oliwia	POL
	TKACHOVA Anna	UKR



FINAL RESULTS		
1.	SKORUPIŃSKA Martyna	POL
2.	NAVICKAITE Marta	LTU
3.	VAN DEN HIL Danielle	NED
3.	KIKOLSKA Maja	POL
5.	ISAJEVA Anastasija	LAT
5.	TKACHOVA Anna	UKR
7.	ROBAKIDZE Keti	GEO
7.	STALIONYTE Paulina	LTU

REPECHAGE

ROBAKIDZE K. (GEO)	13	ROBAKIDZE K. (GEO)
AHIEIEVA A. (UKR)		
VAN DEN HIL D. (NED)	14	VAN DEN HIL D. (NED) 00 s0/ 10 s0 [01:44]
SZYMANIAK G. (POL)		
STALIONYTE P. (LTU)	15	STALIONYTE P. (LTU) 00 s0/ 10 s0 [01:44]
JOHANNESEN E. (NOR)		
TKACHOVA A. (UKR)	16	TKACHOVA A. (UKR) 00 s0/ 10 s0 [01:44]

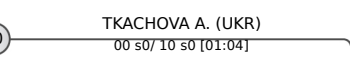
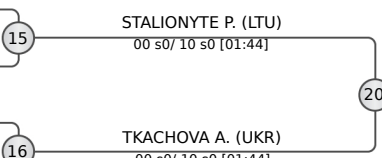
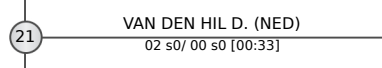
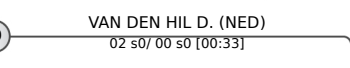

POOL A

	BANASZEWSKA Zuzanna	POL
	ZAREBA Nikola	POL
	EININGE Saule	LTU

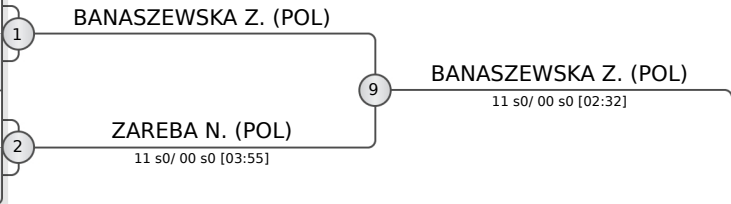

POOL B

	POGOSYAN Gayane	EST
	KVARATSKHELIA Nona	GEO

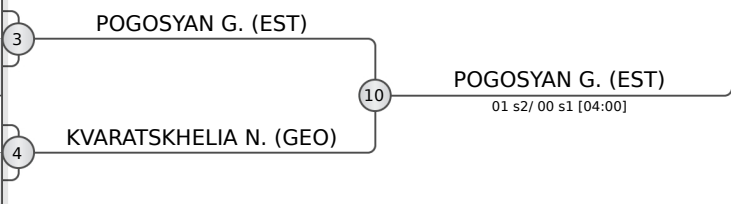

POOL C

	TURDAZHIEVA Akmarzhan	KGZ
	PIECHNA Olga	POL
	KVARTSKHAVA Lizi	GEO

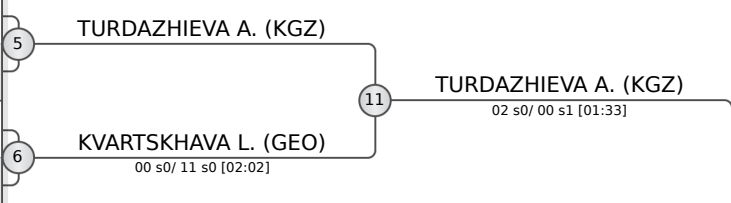

POOL D

	GELASHVILI Barbare	GEO
	TROKA Julia	POL
	TALVET Iti	EST

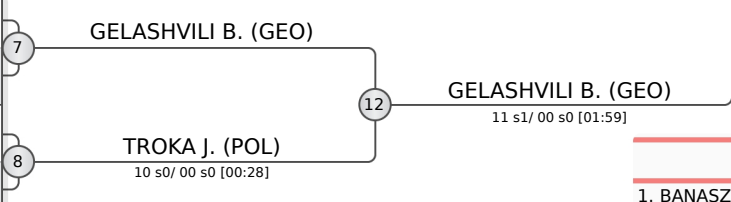

REPECHAGE

ZAREBA N. (POL)	13
KVARATSKHELIA N. (GEO)	14
KVARTSKHAVA L. (GEO)	15
TROKA J. (POL)	16

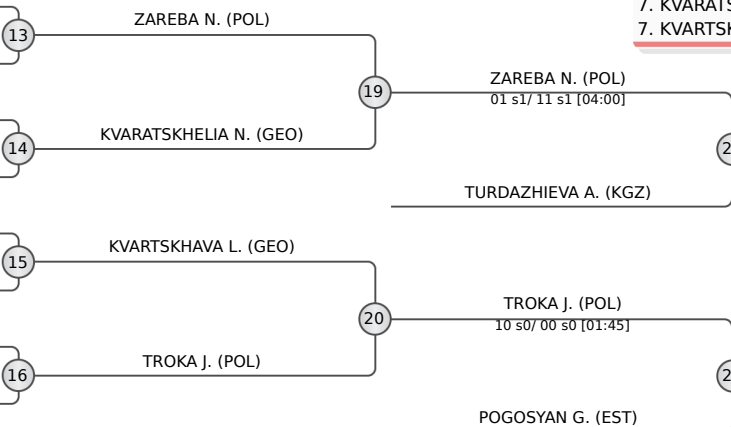

FINAL RESULTS		
1.	BANASZEWSKA Zuzanna	POL
2.	GELASHVILI Barbare	GEO
3.	TURDAZHIEVA Akmarzhan	KGZ
3.	TROKA Julia	POL
5.	ZAREBA Nikola	POL
5.	POGOSYAN Gayane	EST
7.	KVARATSKHELIA Nona	GEO
7.	KVARTSKHAVA Lizi	GEO