

POOL A

BANASZEWSKA Zuzanna POL

BANASZEWSKA Z. (POL)

POOL B

PRUESSE Elina GER
 DELLA VALLE Maria Pia Fabiana ITA

PRUESSE E. (GER)

02 s0/ 00 s0 [02:02]

POOL C

TURDAZHIEVA Akmarzhan KGZ

TURDAZHIEVA A. (KGZ)

POOL D

WIDLAK Nicole POL
 HARTMEIJER Lindey NED

WIDLAK N. (POL)

02 s0/ 00 s1 [03:07]

REPECHAGE

DELLA VALLE M. (ITA)

DELLA VALLE M. (ITA)

HARTMEIJER L. (NED)

HARTMEIJER L. (NED)

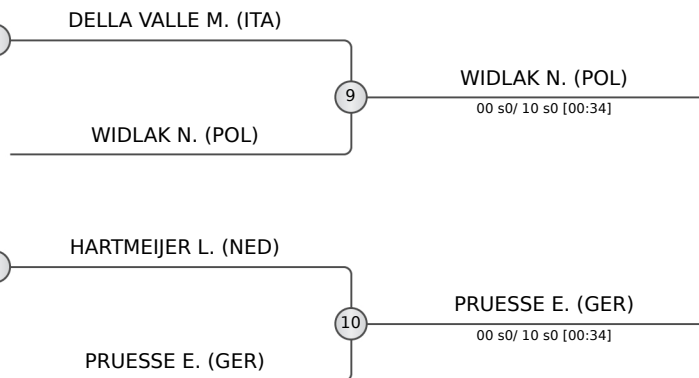
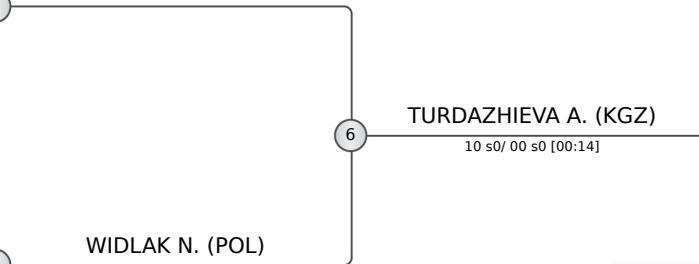
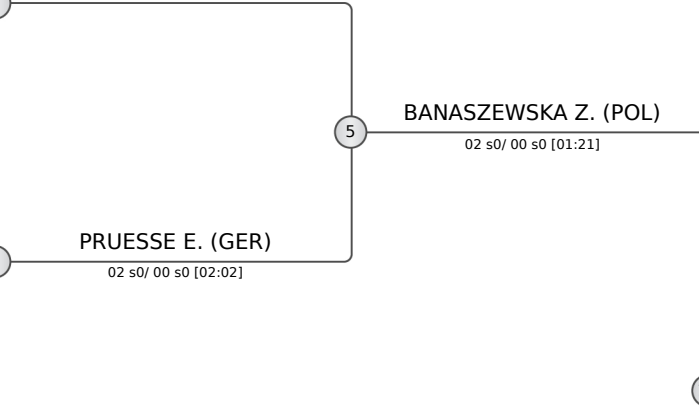

BANASZEWSKA Z. (POL)
10 s0/ 00 s1 [02:23]

FINAL RESULTS		
1.	BANASZEWSKA Zuzanna	POL
2.	TURDAZHIEVA Akmarzhan	KGZ
3.	WIDLAK Nicole	POL
3.	PRUESSE Elina	GER
5.	DELLA VALLE Maria Pia Fabiana	ITA
5.	HARTMEIJER Lindey	NED



Berlin Cadet European Cup 2023

Germany, Berlin, 14-15 Oct 2023

-70 kg

Cadets (18)

POOL A

	BAUR Coco-Mia	GER
	MOSTERMAN Ellemiek	NED
	WAGNER Emelie	GER
	NEUBERT Lara	GER

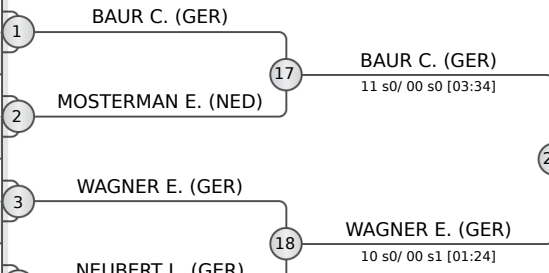

POOL B

	RULLIER Lucie	FRA
	GANZA Jana	GER
	KOOMAN Romy	NED
	NEUMANN Malin	GER
	REGAZZONI Alessandra	SUI

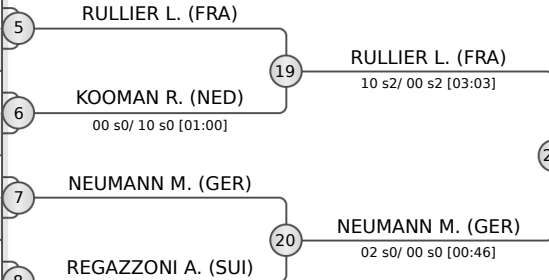

POOL C

	HAPPE Lilli	GER
	FEUILLET--NGUIMGO Emma	FRA
	HAMAD Jasmien	NED
	KOLNY Oktawia	POL
	MANUKYAN Mia	GER

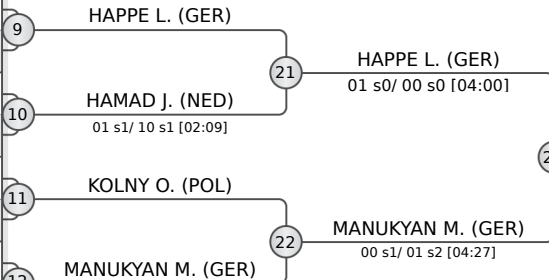

POOL D

	JACOBS Kiki	NED
	MUELLER Hannah	GER
	LUEDEMANN Jessie	GER
	AMARIR Naila	FRA

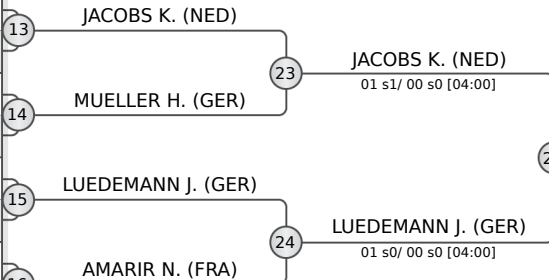

REPECHAGE

29	MOSTERMAN E. (NED)	33	WAGNER E. (GER)
30	KOOMAN R. (NED)	34	NEUMANN M. (GER)
31	HAMAD J. (NED)	35	MANUKYAN M. (GER)
32	MUELLER H. (GER)	36	LUEDEMANN J. (GER)

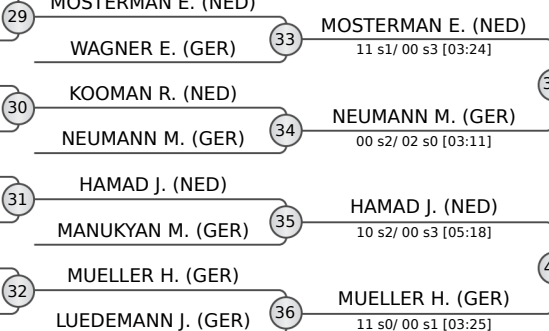

FINAL RESULTS	
1.	RULLIER Lucie
2.	JACOBS Kiki
3.	MOSTERMAN Ellemiek
3.	HAMAD Jasmien
5.	HAPPE Lilli
7.	BAUR Coco-Mia
7.	NEUMANN Malin
7.	MUELLER Hannah





Berlin Cadet European Cup 2023

Germany, Berlin, 14-15 Oct 2023

-63 kg

Cadets (33)

POOL A

	PTASINSKA Amelia	POL	1	PTASINSKA A. (POL)
	WOLSFELD Sara-Tamar	GER	2	WOLSFELD S. (GER)
	SCHRICKX Rosalien	NED	3	SCHRICKX R. (NED)
	KREIDIN Irina	GER	4	KREIDIN I. (GER)
	KONRAD Sveyarike	GER	5	KONRAD S. (GER)
	LUETHI Sinja	SUI	6	LUETHI S. (SUI)
	WAGNER Sophie	GER	7	WAGNER S. (GER)
	MBAYE Lea	FRA	8	MBAYE L. (FRA)

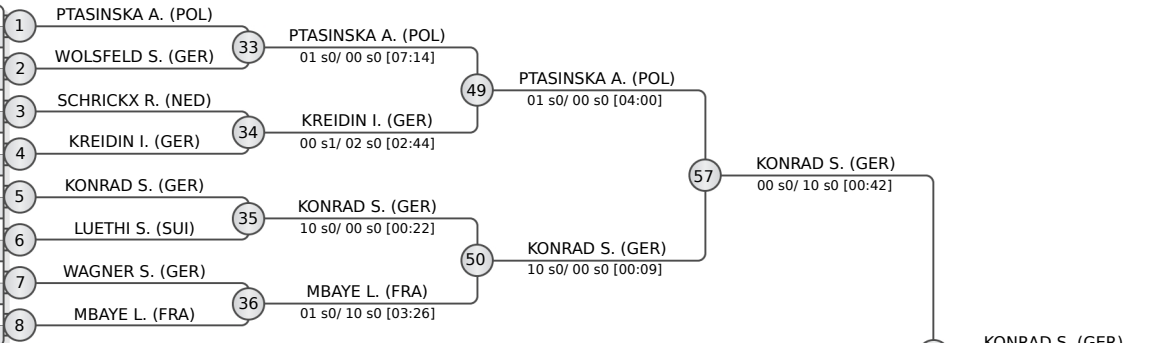

POOL B

	BOTZHEIM Bodza	HUN	9	BOTZHEIM B. (HUN)
	BOELCSKEI Hanna	GER	10	BOELCSKEI H. (GER)
	OFFENBERG Leah	NED	11	OFFENBERG L. (NED)
	GHEYSSENS Louise	BEL	12	GHEYSSENS L. (BEL)
	MATSIRIDI Sophia	GER	13	MATSIRIDI S. (GER)
	SCHILLINGS Chloé	LUX	14	SCHILLINGS C. (LUX)
	STEINEBRUNNER Salome	GER	15	STEINEBRUNNER S. (GER)
	SPINDER Faye	NED	16	SPINDER F. (NED)

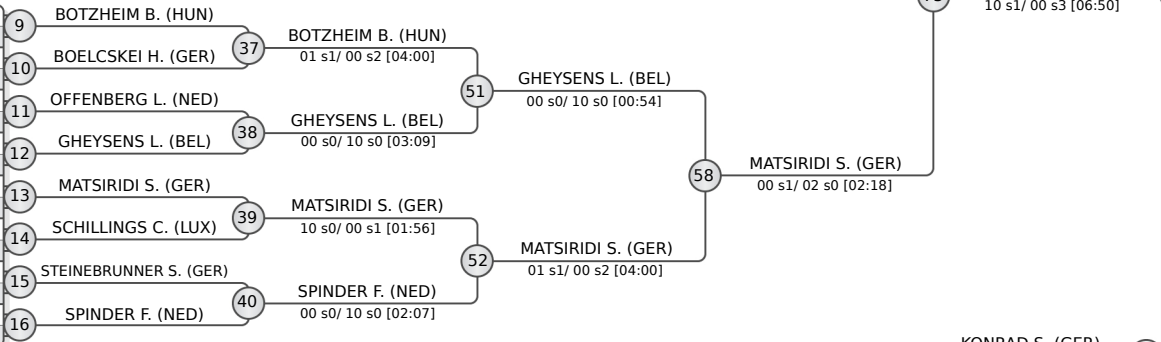

POOL C

	VAN DER MAAS Kim	NED	17	VAN DER MAAS K. (NED)
	GOTTSCHALK Hedda	GER	18	GOTTSCHALK H. (GER)
	BEETERENS Hanne	BEL	19	BEETERENS H. (BEL)
	GARLAND Marley	GER	20	GARLAND M. (GER)
	HANGYI Eva	NED	21	HANGYI E. (NED)
	GARAMI Leticia	SUI	22	GARAMI L. (SUI)
	LORENZ Anna	GER	23	LORENZ A. (GER)
	SCHENK Magdalena	POL	23	SCHENK M. (POL)
	GHERASUDIS Alessia Sophia	GER	24	GHERASUDIS A. (GER)

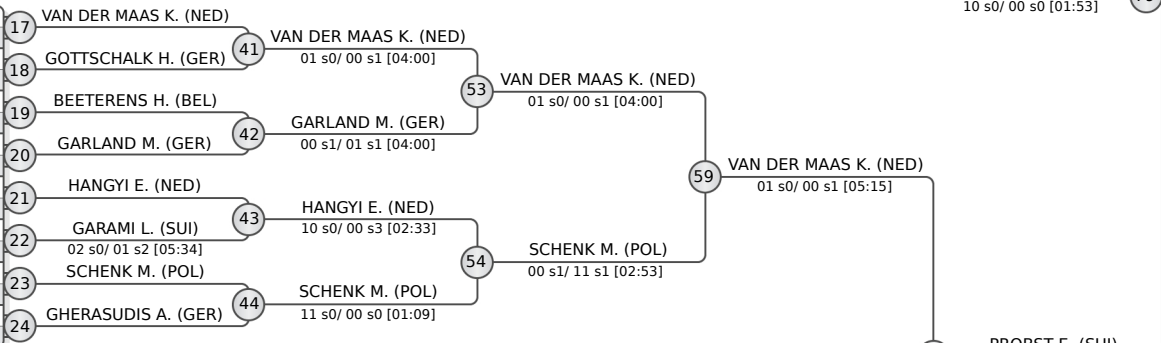

POOL D

	PROBST Eileen	SUI	25	PROBST E. (SUI)
	ECKMANN Greta	GER	26	ECKMANN G. (GER)
	KEELER Flox	NED	27	KEELER F. (NED)
	SCHLIEPER Carlotta	GER	28	SCHLIEPER C. (GER)
	TATAJ Julia	POL	29	TATAJ J. (POL)
	VUKICEVIC Dunja	SRB	30	VUKICEVIC D. (SRB)
	RIDDERING Suus	NED	31	RIDDERING S. (NED)
	WINTER Leya	GER	32	WINTER L. (GER)

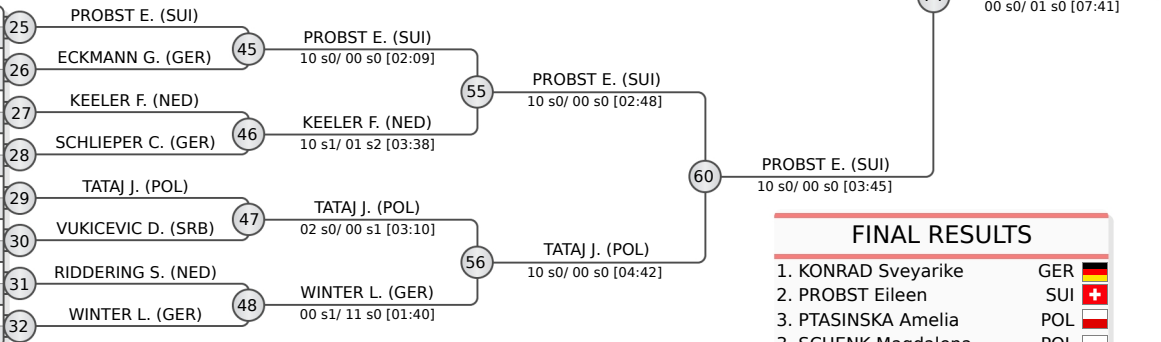

FINAL RESULTS	
1.	KONRAD Sveyarike GER
2.	PROBST Eileen SUI
3.	PTASINSKA Amelia POL
3.	SCHENK Magdalena POL
5.	VAN DER MAAS Kim NED
5.	MATSIRIDI Sophia GER
7.	GHEYSSENS Louise BEL
7.	KEELER Flox NED

REPECHAGE

LUETHI S. (SUI)	61	LUETHI S. (SUI)	65	MBAYE L. (FRA)
SCHILLINGS C. (LUX)	62	SCHILLINGS C. (LUX)	66	SPINDER F. (NED)
GOTTSCHALK H. (GER)	63	GOTTSCHALK H. (GER)	67	GARLAND M. (GER)
ECKMANN G. (GER)	64	ECKMANN G. (GER)	68	KEELER F. (NED)

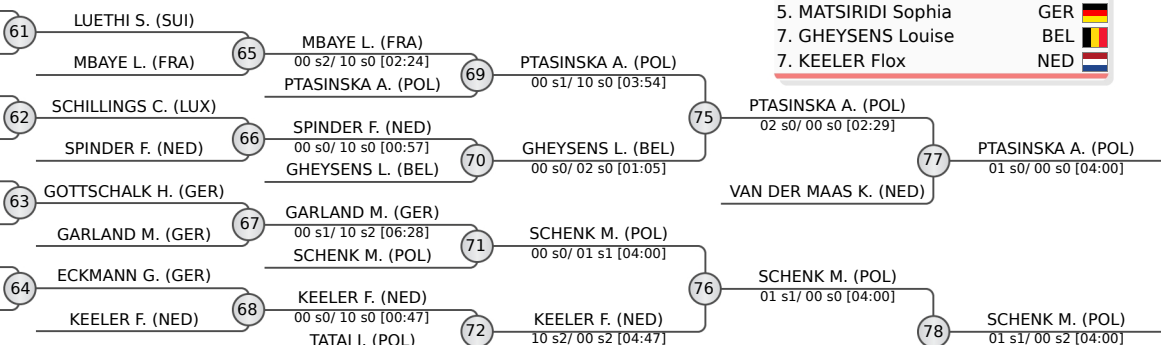



Berlin Cadet European Cup 2023

Germany, Berlin, 14-15 Oct 2023

-57 kg

Cadets (37)

POOL A

1	TKACHENKO Alyssa (CAN)	1	TKACHENKO A. (CAN)
2	SCHOONEN Liv (NED)	33	TKACHENKO A. (CAN)
3	RASIMENOKA Marija (LAT)	34	RASIMENOKA M. (LAT)
4	BOZKURT Narin (GER)	34	RASIMENOKA M. (LAT)
5	D ALESSANDRO Erica (ITA)	35	SCHIPPER Y. (NED)
6	KOSTER Skadi (GER)	35	SCHIPPER Y. (NED)
7	SCHIPPER Yael (NED)	36	DUDA J. (POL)
8	DOERR Lisa Charlotte (GER)	36	DUDA J. (POL)

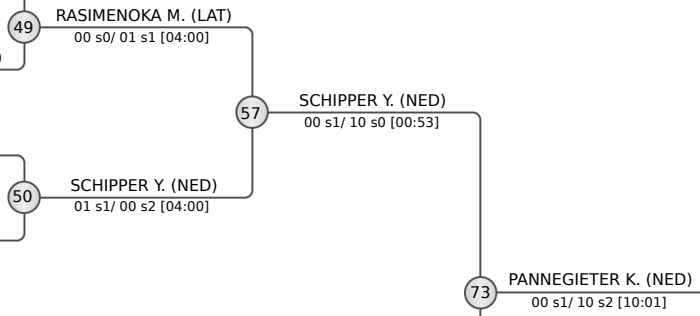

POOL B

9	PANNEGIETER Kaya (NED)	9	PANNEGIETER K. (NED)
10	GUMPRECHT Amely (GER)	37	PANNEGIETER K. (NED)
11	TILLEMA Luna (NED)	38	TILLEMA L. (NED)
12	KUZMINSKA Oliwia (POL)	38	TILLEMA L. (NED)
13	CINAGROSSI Emma (SUI)	39	TOSZEGI M. (GER)
14	KOLAKOWSKA Zuzanna (POL)	39	TOSZEGI M. (GER)
15	TOSZEGI Maya (GER)	40	RICHTER M. (GER)
16	BOZSO Zita (HUN)	40	RICHTER M. (GER)

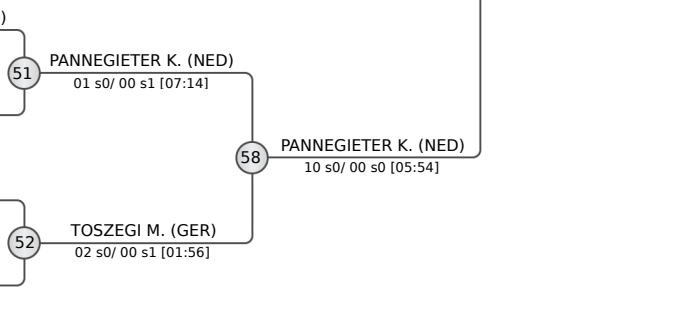

POOL C

17	SORELLI Giulia (ITA)	17	SORELLI G. (ITA)
18	POZANANOVIC Ekaterina (SRB)	41	SORELLI G. (ITA)
19	PLAGGEMARS Hanneke (NED)	42	SPECHT N. (GER)
20	SPECHT Nelly (GER)	42	SPECHT N. (GER)
21	KRAEHENBUEHL Emilie (SUI)	43	KRAEHENBUEHL E. (SUI)
22	BEISSENHIRTZ Julia (GER)	43	KRAEHENBUEHL E. (SUI)
23	KAISER Katharina (GER)	44	WALEGA M. (POL)
24	GUDDENS Senna (NED)	44	WALEGA M. (POL)

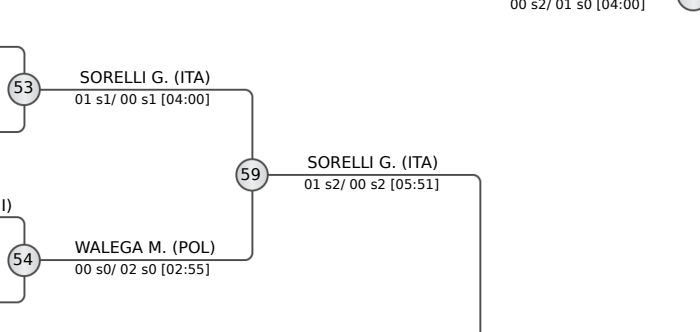

POOL D

25	SEMOUD Luna (GER)	25	SEMOUD L. (GER)
26	BOELSMA Mila (NED)	45	BOELSMA M. (NED)
27	MOECK Helen (GER)	46	ZUEND A. (SUI)
28	STERRENBURG Lieka (NED)	46	ZUEND A. (SUI)
29	ZUEND Annika (SUI)	47	BALZER V. (GER)
30	KWAPIS Kinga (POL)	47	BALZER V. (GER)
31	BALZER Valeria (GER)	48	PANTANOWITZ L. (ISR)
32	PANTANOWITZ Lilach (ISR)	48	PANTANOWITZ L. (ISR)

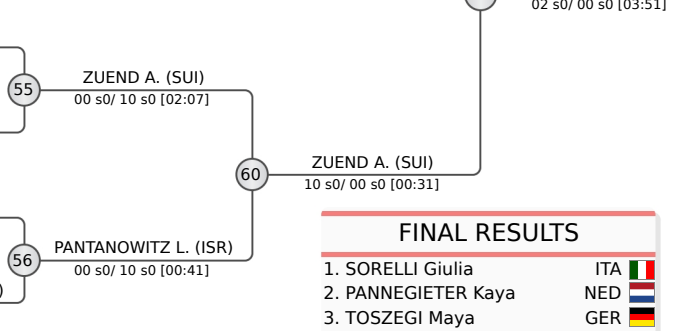

REPECHAGE

61	KOSTER S. (GER)	61	KOSTER S. (GER)
62	D ALESSANDRO E. (ITA)	65	DUDA J. (POL)
63	GUMPRECHT A. (GER)	65	RASIMENOKA M. (LAT)
64	GUMPRECHT A. (GER)	66	GUMPRECHT A. (GER)
		66	TOSZEGI M. (GER)
		67	POZANANOVIC E. (SRB)
		67	POZANANOVIC E. (SRB)
		68	STERRENBURG L. (NED)
		68	BOELSMA M. (NED)
		69	DUDA J. (POL)
		69	RASIMENOKA M. (LAT)
		70	TOSZEGI M. (GER)
		70	TOSZEGI M. (GER)
		71	WALEGA M. (POL)
		71	WALEGA M. (POL)
		72	PANTANOWITZ L. (ISR)
		72	PANTANOWITZ L. (ISR)
		73	PANNEGIETER K. (NED)
		73	PANNEGIETER K. (NED)
		74	SORELLI G. (ITA)
		74	SORELLI G. (ITA)
		75	TOSZEGI M. (GER)
		75	TOSZEGI M. (GER)
		76	WALEGA M. (POL)
		76	WALEGA M. (POL)
		77	TOSZEGI M. (GER)
		77	TOSZEGI M. (GER)
		78	WALEGA M. (POL)
		78	WALEGA M. (POL)
		79	SORELLI G. (ITA)
		79	SORELLI G. (ITA)

FINAL RESULTS

- SORELLI Giulia (ITA)
- PANNEGIETER Kaya (NED)
- TOSZEGI Maya (GER)
- WALEGA Magdalena (POL)
- ZUEND Annika (SUI)
- SCHIPPER Yael (NED)
- DUDA Julia (POL)
- PANTANOWITZ Lilach (ISR)





Berlin Cadet European Cup 2023

Germany, Berlin, 14-15 Oct 2023

+ 90 kg
Cadets (11)

POOL A

	WILHELM Christian	GER
	FLOREK Michał	POL
	BALLERING Thijn	NED

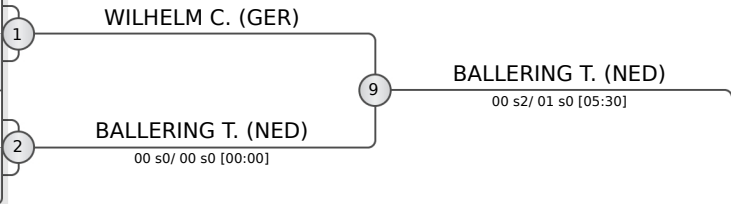

POOL B

	FRANSENS Leonhard	NED
	DAMM Felix	GER

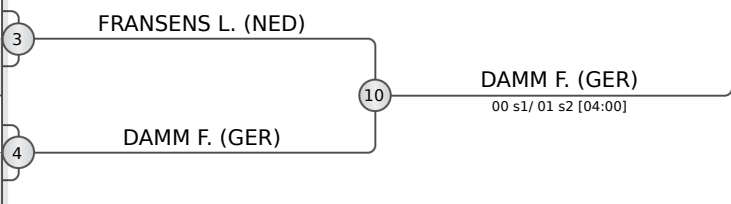

POOL C

	DE HAAN Kelvin	NED
	RISUKHIN Bohdan	UKR
	SCHULZ Finn	GER

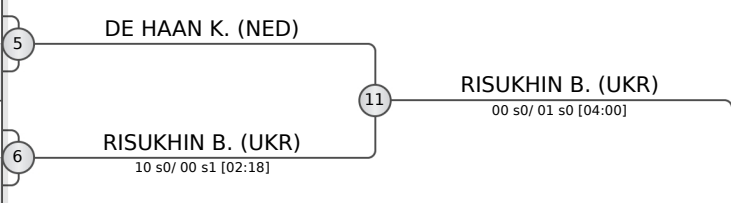

POOL D

	OLDENHOF Steyn	NED
	KHACHATRYAN Anton	POL
	KOREVAAR Dwayne	NED

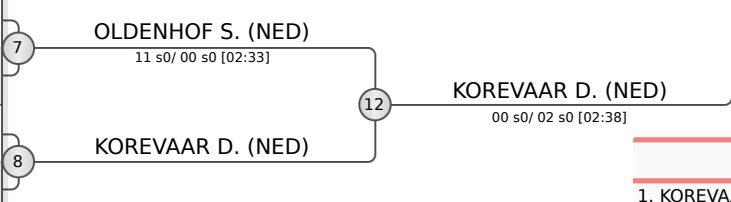

REPECHAGE

FLOREK M. (POL)	WILHELM C. (GER)
WILHELM C. (GER)	FRANSENS L. (NED)
FRANSENS L. (NED)	SCHULZ F. (GER)
SCHULZ F. (GER)	DE HAAN K. (NED)
DE HAAN K. (NED)	OLDENHOF S. (NED)
OLDENHOF S. (NED)	

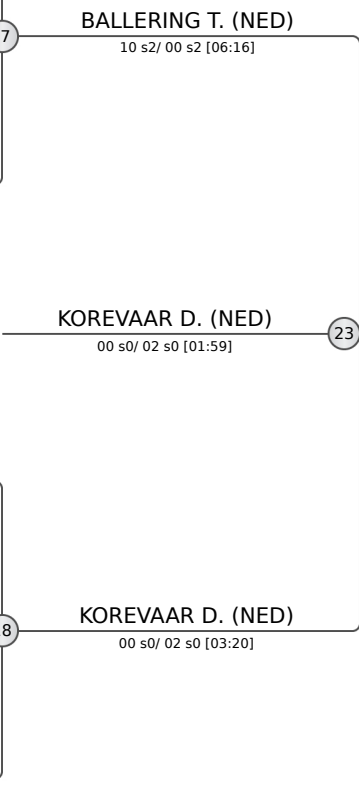
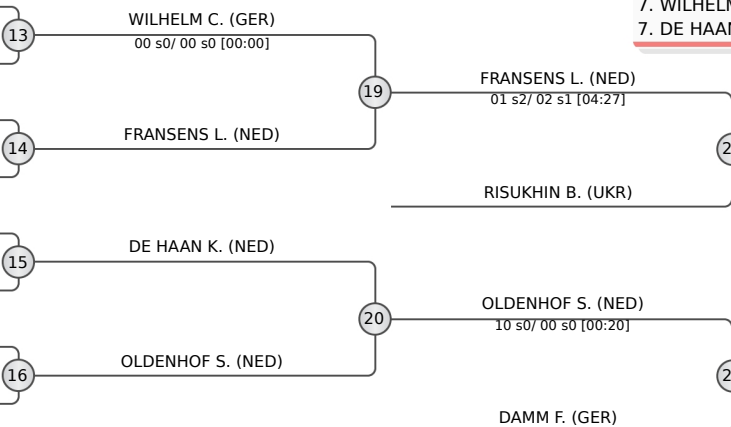

FINAL RESULTS		
1. KOREVAAR Dwayne	NED	
2. BALLERING Thijn	NED	
3. RISUKHIN Bohdan	UKR	
3. OLDENHOF Steyn	NED	
5. FRANSENS Leonhard	NED	
5. DAMM Felix	GER	
7. WILHELM Christian	GER	
7. DE HAAN Kelvin	NED	





Berlin Cadet European Cup 2023

Germany, Berlin, 14-15 Oct 2023

-90 kg

Cadets (19)

POOL A

	WACKO Mateusz	POL
	FOUKAL Ondrej	CZE
	DA CRUZ Matteo	LUX
	DUIKER Redmer	NED
	BISCHOFF Samuel	GER

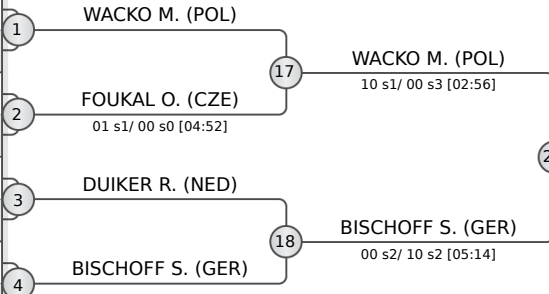

POOL B

	DE LUCA Leandro	GER
	KOZLOWSKI Maciej	POL
	GORDON Kevin	GBR
	KALMOUKIDIS Nikolaos	GER
	BUERGISSER Kai	SUI

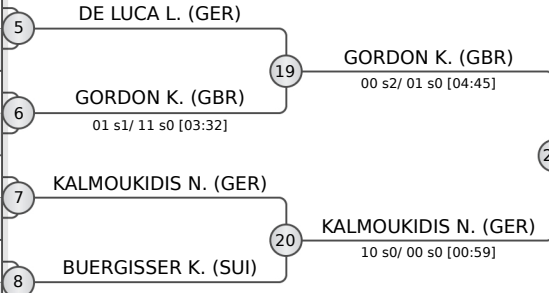

POOL C

	NEDERBRAGT Bram	NED
	WELTER Micha	LUX
	SPRYDONOV Daniil	UKR
	SCHINDLER Lasse Tjark	GER

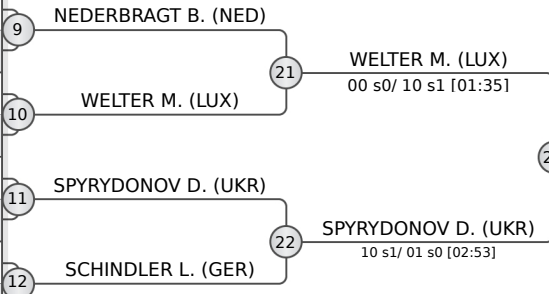

POOL D

	KUKA Blin	KOS
	NGOUMOU David	BEL
	CALDER Jaden	GBR
	GRZESKOWIAK Adam	POL
	RADOWSKY Carl	GER

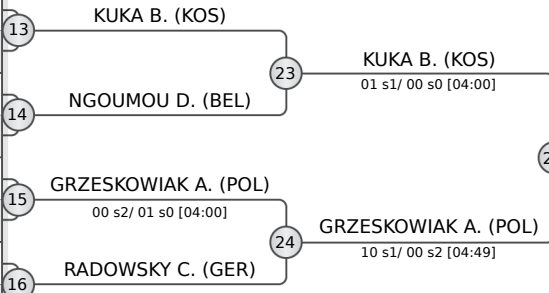

FINAL RESULTS	
1.	WACKO Mateusz (POL)
2.	KUKA Blin (KOS)
3.	FOUKAL Ondrej (CZE)
3.	GRZESKOWIAK Adam (POL)
5.	WELTER Micha (LUX)
7.	KALMOUKIDIS Nikolaos (GER)
7.	GORDON Kevin (GBR)
7.	NEDERBRAGT Bram (NED)

REPECHAGE

29	FOUKAL O. (CZE)
30	BUERGISSER K. (SUI)
31	NEDERBRAGT B. (NED)
32	NGOUMOU D. (BEL)

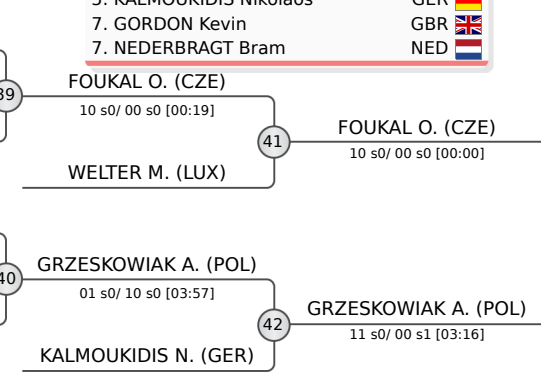
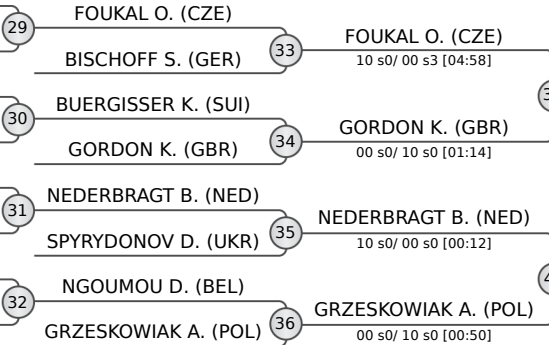



Berlin Cadet European Cup 2023

Germany, Berlin, 14-15 Oct 2023

-81 kg

Cadets (30)

POOL A

	DISTEL Konstantin	GER
	KRAUSS Jan	POL
	PRYBYSHENIA Illia	UKR
	SWIDWA Robert	POL
	GEIGER Daniel	GER
	CLARK Tristan	SUI
	GRIEDE Sieb	NED

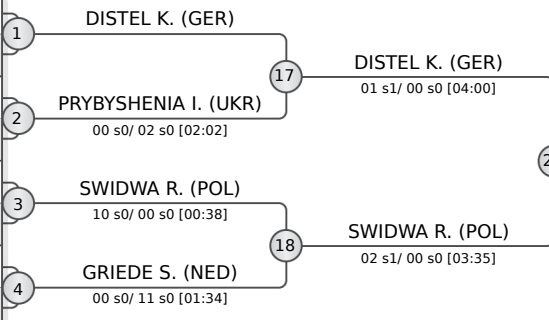

POOL B

	JACENKO Arturs	LAT
	SHELL Rusker	NED
	KUCHARCZYK Quentin	GER
	PASZEK Damian	POL
	YAKHNIN Georgy	GER
	KUCERA Kristian	CZE
	SLOVIC Milos	SRB
	PACARIZ Meris	GER

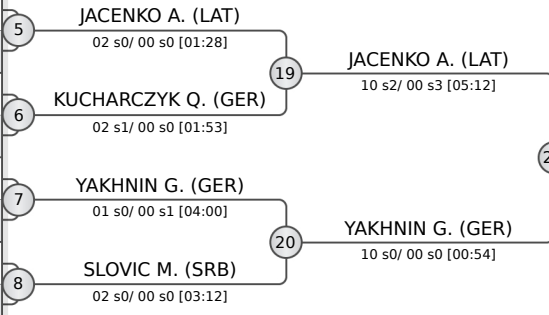

POOL C

	JAKS Adam	CZE
	KRYVYTSKYI Tigran	CAN
	EICHHORN Valentin	GER
	KEDING Emil	GER
	SNIPPE Jouke	NED
	NADYEZHDA Glib	UKR
	MASHKO Dzmitry	POL

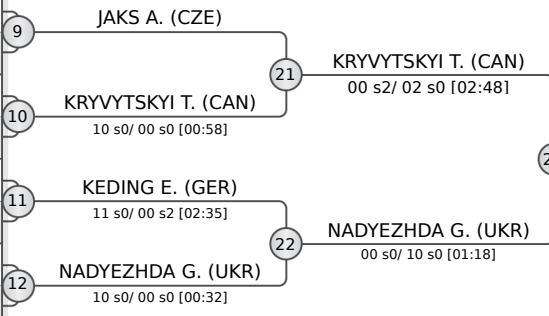

POOL D

	CLAVERIO Marco	ITA
	MARCINEK Maksymilian	POL
	PEROSA Loris	SUI
	MARGOLIN Alexander Lukas	GER
	GUSIC Imran	BIH
	OBRADOVIC Nikola	SRB
	LIBUDA Jan	GER
	HULIN Kamil	POL

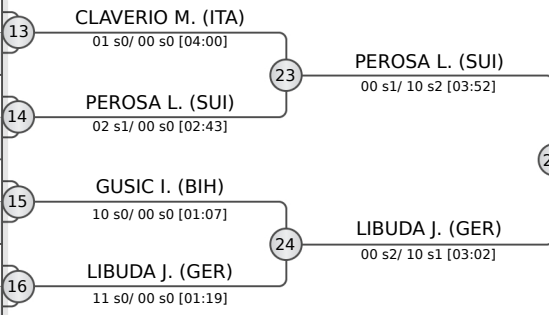

REPECHAGE

29 PRYBYSHENIA I. (UKR)	30 SLOVIC M. (SRB)	31 JAKS A. (CZE)	32 CLAVERIO M. (ITA)
33 SWIDWA R. (POL)	34 JACENKO A. (LAT)	35 NADYEZHDA G. (UKR)	36 LIBUDA J. (GER)

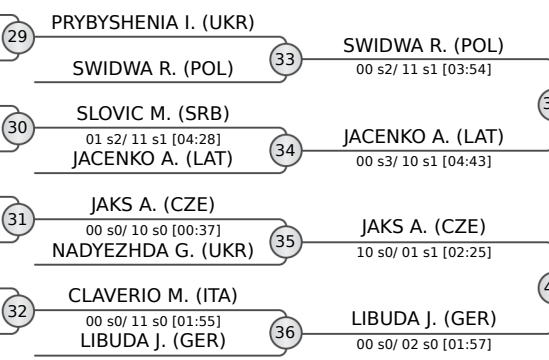

FINAL RESULTS	
1.	KRYVYTSKYI Tigran CAN
2.	YAKHNIN Georgy GER
3.	PEROSA Loris SUI
3.	DISTEL Konstantin GER
5.	JACENKO Arturs LAT
5.	JAKS Adam CZE
7.	SWIDWA Robert POL
7.	LIBUDA Jan GER





Berlin Cadet European Cup 2023

Germany, Berlin, 14-15 Oct 2023

-73 kg

Cadets (37)

POOL A

1	MURATOV Nurmukammed KGZ	1	MURATOV N. (KGZ)
2	MUELLER Aaron SUI	2	MUELLER A. (SUI)
3	SIEVERT Herman GER	3	AHMATOV I. (GER)
4	AHMATOV Islam GER	4	LOEWEN M. (GER)
5	LOEWEN Musa GER	5	LALEIKE Y. (GER)
6	LALEIKE Yoshiya GER	6	REICH N. (GER)
7	REICH Nevio GER	7	VOGTMANN A. (GER)
8	VOGTMANN Andreas GER	8	POSPISIL M. (CZE)
	POSPISIL Matej CZE		

POOL B

9	YOSUL Can Ilias GER	9	YOSUL C. (GER)
10	ENES Gabriel FRA	10	ENES G. (FRA)
11	DEN BROEDER Kuba NED	11	BECKER G. (GER)
12	BECKER Georg GER	12	AKOTO R. (GER)
13	AKOTO Raphael GER	13	FRIEDRICHS P. (GER)
14	FRIEDRICHS Paul GER	14	SCHULZE L. (GER)
15	SCHULZE Ludwig GER	15	KRAEMER G. (GER)
16	KRAEMER Georg GER	16	KWIECINSKI A. (POL)
	KWIECINSKI Antoni POL		

POOL C

17	HANADA Heinrich USA	17	HANADA H. (USA)
18	GRUBER Julius GER	18	GRUBER J. (GER)
19	DISTEL Roman GER	19	DISTEL R. (GER)
20	ZALEVSKIS Fjodors LAT	20	DOBBECK C. (GER)
21	DOBBECK Colin GER	21	VOLZ M. (GER)
22	VOLZ Mark GER	22	SOMMER V. (GER)
23	SOMMER Valentin GER	23	MANNBEEK Luuk NED
24	MANNBEEK Luuk NED	24	MARTINI N. (GER)
	MARTINI Nicolas GER		
	HEINEMANN Erik GER		

POOL D

25	IVTCHENKO Josef GER	25	IVTCHENKO J. (GER)
26	BULINGER Eduard GER	26	BULINGER E. (GER)
27	BETKOWSKI Jeremiasz POL	27	BETKOWSKI J. (POL)
28	ROEDER Henry GER	28	ROEDER H. (GER)
29	NEYOLOV Artem CAN	29	NEYOLOV A. (CAN)
30	NOACK Melvin GER	30	NOACK M. (GER)
31	SCHUESSLER Francesco GER	31	SCHUESSLER F. (GER)
32	REBELO OSORIO Marcos LUX	32	PFOTENHAUER T. (GER)
	PFOTENHAUER Thorben GER		

REPECHAGE

61	REICH N. (GER)	61	REICH N. (GER)
62	SCHULZE L. (GER)	62	SCHULZE L. (GER)
63	MARTINI N. (GER)	63	MARTINI N. (GER)
64	NOACK M. (GER)	64	NOACK M. (GER)
65	POSPISIL M. (CZE)	65	POSPISIL M. (CZE)
66	SCHULZE L. (GER)	66	SCHULZE L. (GER)
67	SOMMER V. (GER)	67	SOMMER V. (GER)
68	PFOTENHAUER T. (GER)	68	PFOTENHAUER T. (GER)
69	MURATOV N. (KGZ)	69	MURATOV N. (KGZ)
70	AKOTO R. (GER)	70	AKOTO R. (GER)
71	HANADA H. (USA)	71	HANADA H. (USA)
72	ROEDER H. (GER)	72	ROEDER H. (GER)

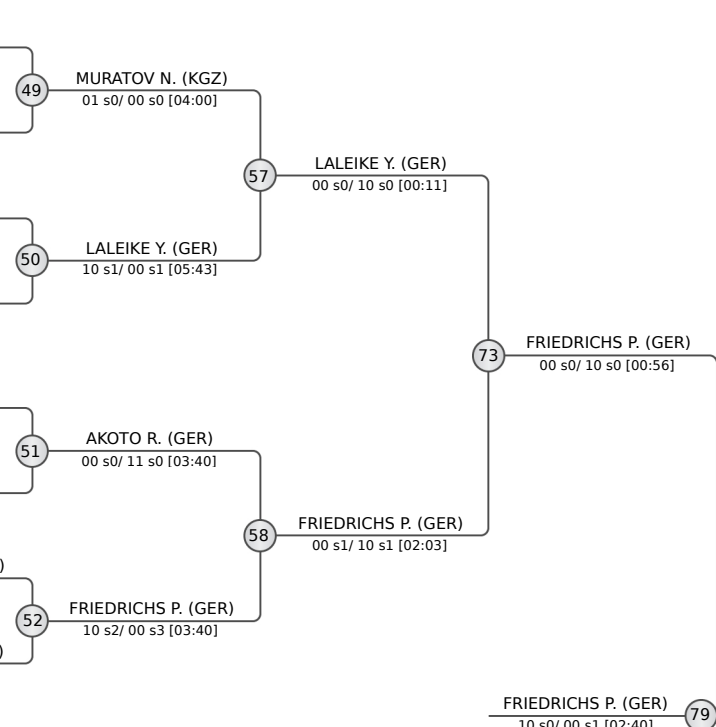

1.	FRIEDRICHS Paul	GER
2.	NEYOLOV Artem	CAN
3.	MURATOV Nurmukammed KGZ	KGZ
3.	LALEIKE Yoshiya	GER
5.	HEINEMANN Erik	GER
7.	PFOTENHAUER Thorben	GER
7.	AKOTO Raphael	GER
7.	SOMMER Valentin	GER

